

Cobolt 04 – 01 Series

Powerful | Single Frequency | CW Diode pumped lasers

457 nm	515 nm	594 nm
473 nm	532 nm	660 nm
491 nm	561 nm	1064 nm

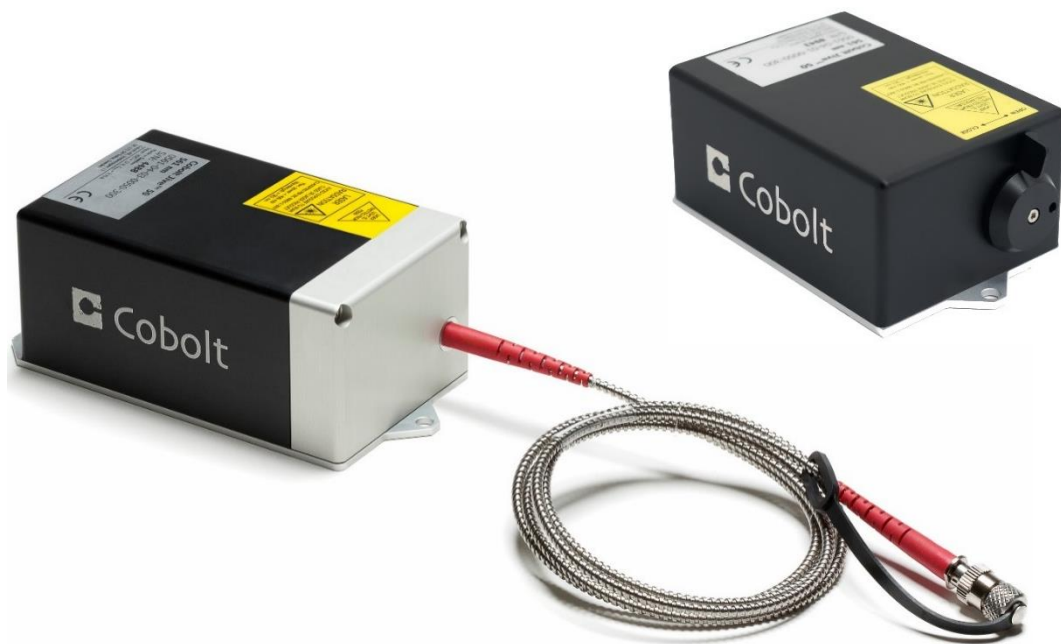

CONTENTS

1.	Introduction	5
2.	Safety	6
2.1.	Beam Hazards	7
2.2.	Safety features	8
2.3.	Equipment Safety	9
2.4.	Warning and Identification Labels	10
3.	Overview	12
3.1.	Model number	12
3.2.	Configuration	13
3.3.	Laser head	14
3.4.	Controller	15
3.5.	Controller Cable	15
3.6.	Thermal Management	16
3.7.	Power Supply Requirements	16
4.	System Description	17
4.1.	Specification	17
4.2.	Mechanical Drawings	19
4.3.	Remote Interlock Connector	21
4.4.	Direct ON/OFF control	21
4.5.	Pin assignment	22
5.	Operating Instructions	23
5.1.	Installation start-up operation	23
5.2.	Shutdown procedure operation	23
6.	Operating Modes	23
7.	Operation via data port	24
7.1.	Handshaking	24
7.2.	RS232 communication	24
7.3.	USB communication	24
7.4.	Communication commands	25
8.	Cobolt Monitor™ Software	26
8.1.	Installation	26
8.2.	Software instructions	26
9.	Troubleshooting	29
10.	Warranty and Maintenance	29
11.	Service	29
12.	Compliance (CDRH models only)	30
13.	Disclaimer	31

1. Introduction

The Cobolt o4-o1 Series lasers are continuous-wave diode-pumped laser (DPL) devices operating at a fixed wavelength between 457 nm and 1064 nm. The lasers are built using proprietary HTCure™ manufacturing technology for ultra-robustness in a compact hermetically sealed package.

The lasers emit a very high quality laser beam with stable characteristics over a wide range of operating conditions. Single frequency operation provides a narrow spectral bandwidth and long coherence length. The lasers are designed and manufactured to ensure a high level of reliability.

The Cobolt o4-o1 Series lasers are intended for stand-alone use in laboratory environments or for integration as an OEM component in instruments for applications including fluorescence microscopy, flow cytometry, DNA sequencing, HCA, Raman spectroscopy, interferometry, holography and particle analysis.

The Cobolt o4-o1 Series of compact high performance single frequency diode pumped lasers can be supplied with robust fiber delivery option. The fiber is permanently aligned and fixed inside the hermetically sealed package using Cobolt's proprietary HTCure™ Technology, providing stable output over a large temperature range and insensitive to transport conditions. The design is suitable for OEM use and type of fiber, connector and lengths can be customized. The coupling efficiency (into SM/PM fiber) is typically > 80 %, output power is specified as out of the fiber.

2. Safety

All Cobolt o4-o1 Series lasers are Class IIIB (CDRH), Class 3B (IEC) laser products that emit less than 500 mW of laser radiation within the visible and near-infrared spectrum (NIR). Residual emissions from the pump diode are contained within the laser head housing via filtering optics. The residual emission does not exceed Laser Class 1.

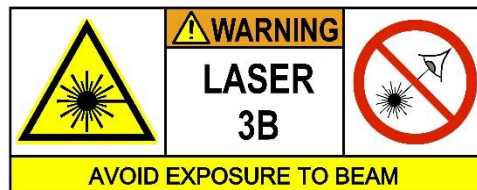

Eye and skin exposure to direct or reflected laser light is hazardous and may be extremely harmful. Always wear eye protection appropriate to the beam wavelength and intensity. Class 3B lasers may pose a risk of igniting flammable materials and in event of ignition gasses and fumes may be generated. All equipment used in close proximity to the laser beam should be suitably fire resistant and the facility should be properly ventilated. It is advised to perform a risk assessment for the facility and equipment prior to using the laser. In the case of integration into a larger system, laser safety compliance must be evaluated in the end product.

The device must be handled by skilled personnel experienced with lasers, in a laboratory environment and with access to adequate laser safety equipment. The laser head clearly displays a yellow warning label that shows the location of the laser beam aperture. This label must be visible unless the laser beam is totally enclosed.

Symbols in the manual



WARNING – LASER RADIATION This symbol is used to call attention to important laser safety information



WARNING – STATIC MAGNETIC FIELD This symbol is used to call attention to important magnetic field safety information



CAUTION – GENERAL This symbol is used to call attention to important general operator and equipment safety information



NOTICE – GENERAL This symbol is used to call attention to best practices when using the equipment and does not indicate a hazard.

2.1. Beam Hazards

Eye and skin exposure to direct or reflected laser light is hazardous and may be extremely harmful. Always wear eye protection appropriate to the beam wavelength and intensity. Lasers may pose a risk of igniting flammable materials and in event of ignition gasses and fumes may be generated. All equipment used in close proximity to the laser beam should be suitably fire resistant and the facility should be properly ventilated. It is advised to perform a risk assessment for the facility and equipment prior to using the laser. In the case of integration into a larger system, laser safety compliance must be evaluated in the end product.



WARNING Remove all watches, rings, and other reflective jewelry before working with lasers.

Always wear the appropriate eye protection from the wavelengths integrated into the system.

Verify the accessible emission wavelength and power before operating. **Never look directly into a laser beam.**



The device must be handled by skilled personnel experienced with lasers, in a laboratory environment and with access to adequate laser safety equipment. The laser head clearly displays a yellow warning label that shows the location of the laser beam aperture. This label must be visible unless the laser beam is totally enclosed. If the laser does not function, do not attempt to open any part of the device, or the warranty will be voided. Call or e-mail your local Cobolt representative for consultancy and to request an RMA number (see back cover for contact information).

Laser radiation may ignite flammable materials and combustible gasses in the beam path and, in event of ignition, fumes may be generated. All equipment used in close proximity to the laser beam should be suitably fire resistant and the facility should be properly ventilated.



CAUTION Use of controls or adjustments or performance of any procedures other than those specified herein may result in exposure to hazardous radiation.

The equations below describe how to use the nominal output power (mW) and beam area to calculate the irradiance (W/cm²) and how to use the Warning label (Max) power (mW) and the Accessible Emission Limit (AEL) (mW) per laser safety standard IEC 60825-1:2014 to calculate the required optical density (OD) for eye protection per wavelength.

$$\text{Irradiance} \left(\frac{\text{W}}{\text{cm}^2} \right) = \frac{110 \% \text{ of Nominal Laser Power (mW)}}{\text{Beam area at bottom tolerance (cm}^2\text{)}}$$

$$\text{Require Attenuation of Laser Safety Glasses (OD)} = \log_{10} \left\{ \frac{\text{Warning Label Power (mW)}}{60825 - 1 \text{ Laser Class 1 AEL (mW)}} \right\}$$

The table below describes the irradiance in W/cm² and appropriate level of eye protection in terms of optical density (OD) for each product line.

Product	Wavelength (nm)	Max. Nominal Output Power (mW)	Irradiance (W/cm ²)*	Eye protection Requirement**
Twist™	457 nm	50	17	> OD 4
Blues™	473 nm	50	17	> OD 4
Calypso™	491 nm	100	33	> OD 4
Fandango™	514.4 nm	150	50	> OD 4
Samba™	532 nm	400	132	> OD 4
Jive™	561 nm	200	66	> OD 4
Mambo™	594 nm	100	33	> OD 4
Flamenco™	660 nm	150	50	> OD 4
Rumba™	1064 nm	400	62	> OD 3



WARNING Always wear the appropriate eye protection for all of the specified emitted wavelengths. Verify the accessible emission wavelengths and power levels on the warning label before operating.

2.1.1. Fiber Pigtailed Option

All safety recommendations in section 2 are also valid for the Cobolt o4-o1 Fiber pigtailed laser heads. Additionally, heat generated from absorption of laser radiation by particles on the fiber end may increase the probability of ignition hazards in certain environments. Always clean the fiber end before turning on the laser. In systems where the beam is exposed, fiber end must be mounted <2m from the emission warning LED. It is advised to perform a risk assessment for the facility and equipment prior to using the laser. In the case of integration into a larger system, laser safety compliance must be evaluated in the end product.

2.2. Safety features

The laser is equipped with all required safety features as described in the laser safety standard 60825-1.

Remote Interlock Connector

The remote interlock connector is a connector which permits the connection of external controls placed apart from other components of the laser product. When the terminals of the connector are open-circuited, emission is interrupted and no radiation will be accessible. The remote interlock connector permits easy addition of an external interlock in laser installation. See section 4.3 for a detailed description of the remote interlock circuit and operation.

Manual Shutter (Beam Stop)

The laser head is equipped with a manual shutter, which functions as the beam stop, capable of preventing human access to laser radiation. The aperture location and the open and close positions of the shutter are indicated on the top surface of the laser head. For fiber pigtailed option, the fiber end cap is considered the 'manual shutter'

Key Control

The CDRH compliant model comes with a key-switch on the Controller which must be connected for the laser to operate. When the key is in the OFF position, the diode is prevented from emitting. The key must be actively turned to the ON position each time the laser is powered on. When the key is removed from the system laser radiation is not accessible.

Laser Radiation Emission Warning

The Controller incorporates information LEDs which display whether power is connected, the laser is on, or a fault has occurred. The "ON" LED is illuminated whenever the device is emitting or could emit light. See section 3.4 for details on the controller. The emission warning indicators are also visible in the Cobolt Monitor™ software, see section 8 for details on the control software

2.3. Equipment Safety

Always install the laser system to a properly grounded power outlet. The laser head and controller must be mounted on a common ground plane, such as an optical table. Cobolt lasers contain a laser diode which is sensitive to electrostatic discharge (ESD).

Laser light reflected directly back into the laser head can be damaging to the laser. Choose Cobolt 04-51 lasers where higher immunity to back reflections is required.

It is important to always make sure the fiber end-face is clean before turning the laser on and before connecting the fiber connector in physical contact with another connector. Failure to do so may lead to irreparable damage of the fiber end-face. Do not clean the fiber when the laser is on. We recommend using appropriate equipment for fiber cleaning and inspection.

2.4. Warning and Identification Labels

The upper face of the laser head contains a yellow label with laser safety warning and classification information, the wavelength and maximum power of the unit. It also shows the location of the laser beam from the aperture and indicates the open and close positions of the manual shutter. This label must be visible unless the laser beam is totally enclosed. A silver label showing information about the laser model, manufacturer date and location, and the power supply voltage and current, is located on the laser head. Lasers shipped to customers in the USA also contain a label of CDRH compliance.

2.4.1. Free beam Laser head o4-01 and o4-51

Manufacturer Identification Labels

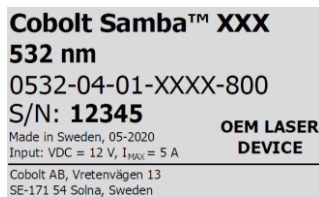

OEM Label

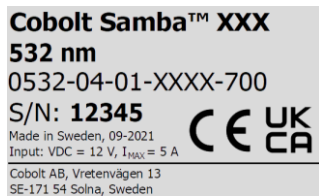

CE marking for CDRH models only



Aperture Warning Labels



Complies with 21 CFR 1040.10 and 1040.11
except for conformance with IEC 60825-1 Ed. 3,
as described in Laser Notice No. 56, dated May 8, 2019.

Laser Notice No. 56 Label
CDRH models shipped to USA

2.4.2. Fiber Pigtailed Laser head o4-03

Manufacturer Identification Labels

Cobolt Samba™ XXX
532 nm
 0532-04-03-XXXX-800
S/N: 12345
 Made in Sweden, 05-2020
 Input: VDC = 12 V, I_{MAX} = 5 A
OEM LASER DEVICE
 Cobolt AB, Vretenvägen 13
 SE-171 54 Solna, Sweden

OEM Label

Cobolt Samba™ XXX
532 nm
 0532-04-03-XXXX-700
S/N: 12345
 Made in Sweden, 09-2021
 Input: VDC = 12 V, I_{MAX} = 5 A
CE UK CA
 Cobolt AB, Vretenvägen 13
 SE-171 54 Solna, Sweden

CE marking for CDRH models only



Aperture Warning Labels

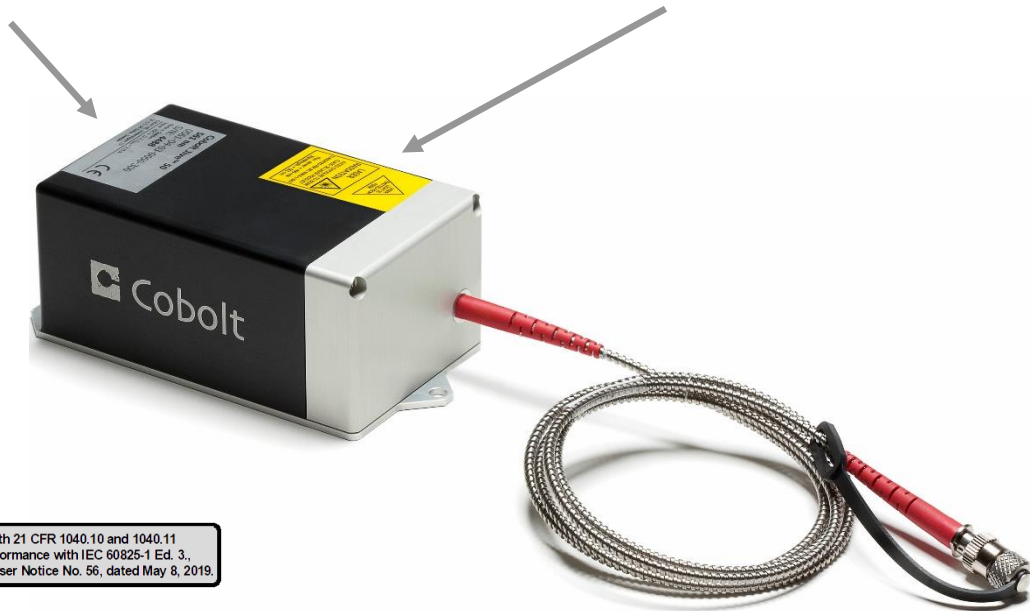

Complies with 21 CFR 1040.10 and 1040.11
 except for conformance with IEC 60825-1 Ed. 3,
 as described in Laser Notice No. 56, dated May 8, 2019.

Laser Notice No. 56 Label
 CDRH models shipped to USA

3. Overview

Cobolt o4-o1 Series laser systems consist of four main parts: the laser head, the Controller, the Cable and the Power Supply (not shown). The cable provided should always be used to connect the laser head with the Controller. Always install the laser system to a properly grounded power outlet.



3.1. Model number

Cobolt o4-o1 Series lasers are sold in two configurations: CDRH and OEM, described in section 3.2. The model numbers are composed as described below.

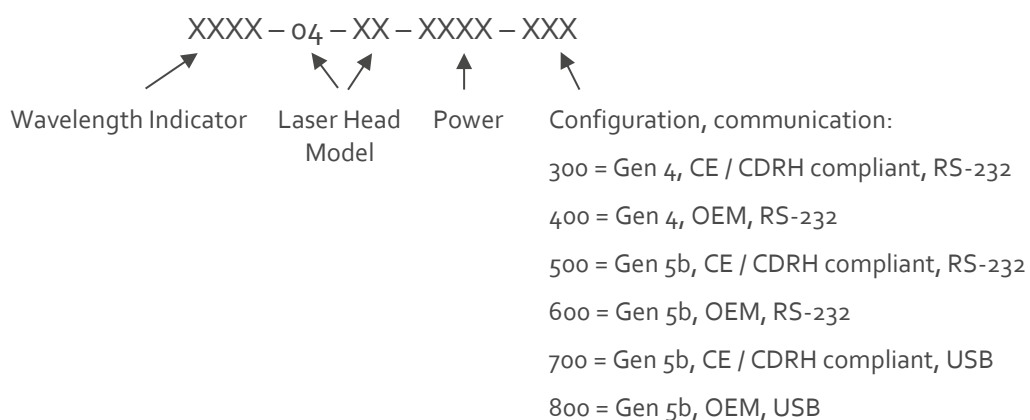

3.2. Configuration

3.2.1. CDRH Compliant

The CDRH compliant system is supplied with a key switch on the Controller, which must be connected, along with a remote interlock connector. Once power is supplied, laser emission starts when the key is turned from the OFF position to the ON position. The status of operation can be monitored via LEDs on the Controller. Setting the key to its OFF position puts the laser in stand-by mode. **The CDRH model is CE compliant.**

The standard CDRH model consists of:

- Laser head
- Controller with key switch
- Keys
- 1(m) Controller Cable
- 12V power supply unit
- Remote interlock jumper (for short circuiting the remote interlock connector)
- Data communication cable

3.2.2. OEM

The OEM system is supplied **without** a key switch on the controller. Connecting the power supply to the controller initiates an automatic start-up sequence. If the remote interlock is connected, laser emission will start automatically as soon as power is supplied and internal temperatures are stabilized.

The OEM model consists of:

- Laser head
- Controller
- Controller Cable
- 12V power supply unit
- Remote interlock jumper (for short circuiting the remote interlock connector)
- Data communication cable

3.3. Laser head

The laser head contains pump diode, laser cavity, beam shaping optics and thermoelectric coolers (TEC) for temperature control of the cavity and pump diode. The laser head contains an optical feed-back loop which ensures long-term power stability of the emitted visual beam. The laser head features a manual mechanical shutter as well as a laser hazard label and a laser classification label. The laser head gets electrical power and control signals from the Controller via a 26-pin HD Sub-D cable. All versions covered in this manual are available with all CDRH and OEM controller configurations. See section 4.1.1 and 4.1.2 for available power levels.

3.3.1. Versions

Free Beam Laser Head 04-01

The standard Cobolt version 04-01 free beam lasers, Twist™ 457nm, Blues™ 473nm, Fandango™ 515nm, Samba™ 532nm, and Jive™ 561nm.

Free Beam Laser Head 04-02

The standard Cobolt version 04-02 free beam lasers with and external temperature control available for all wavelengths but are standard for Calypso™ 491nm and Mambo™ 594nm.

Free Beam Laser Head 04-51

Cobolt version 04-51 are free-beam lasers, are compact versions of the 05-01 series and has a higher immunity to back reflections compared to the 04-01 laser head. Currently Cobolt Samba™ 532 nm, Jive™ 561nm, Flamenco™ 660nm and Rumba™ 1064nm are available in version 04-51.

Free Beam Laser Head 04-11

Cobolt version 04-11 are free-beam lasers with integrated optical isolators to provide high immunity to back reflections. Currently only Cobolt Samba™ 532 nm lasers, up to 320 mW, are available in version 04-11. These lasers are only available in OEM configuration (-4/6/800); the laser head does not include a mechanical shutter, so it is not compliant with the CE or CDRH laser safety standards and is intended for OEM integration only.

Fiber Pigtailed Laser Head 04-03

Cobolt version 04-03 lasers are delivered with a permanently aligned fiber pigtail. The fiber is equipped with a removable dust cap for protection of the fiber end-face. The fiber dust cap serves as the mechanical shutter of the laser system. Cobolt Twist™ 457 nm, Cobolt Blues™ 473nm, Calypso™ 491nm, Fandango™ 515nm, Samba™ 532nm, Jive™ 561nm, and Mambo™ 594nm are available in version 04-03.

Free Beam Laser Head 04-53

Cobolt version 04-53 lasers are delivered with a permanently aligned fiber pigtail. The fiber is equipped with a removable dust cap for protection of the fiber end-face. The fiber dust cap serves as the mechanical shutter of the laser system. Currently Cobolt Samba™ 532 nm ≥ 150 mW, Jive™ 561nm, Flamenco™ 660nm and Rumba™ 1064nm are available in version 04-53.

3.4. Controller

The Controller supplies driving current and control signals to the laser head. All laser heads are delivered with a controller. The operation set points are specific to each Laser Head and have been fixed during manufacturing. The operation set points are stored in the laser head so the controller can be interchanged or replaced.

The status of the laser operation is given via LED indicators:

POW	(green light)	Power is supplied.
ON	(orange light)	Laser light is on in constant current mode.
LOCK	(orange light)	Laser light is on and the output power has been locked to set point. The laser is operating according to specifications.
ERR	(red light)	An error has occurred. No laser light.

When power is supplied to the Controller, regardless of on/off state, the temperature control elements are operating to reach set point values. The Controller includes a remote interlock connector, pin 1-2 according to Section 4.3. The operation of the laser can be controlled and monitored via the data port that supports either USB or RS-232 commands. See Section 7.4 for further details. RS-232 controllers may also be delivered with a RS-232 to USB adaptor.

3.5. Controller Cable

The controller cable connects the laser head to the Controller. The standard (CE compliant) cable length is 1(m) long. The cable has a minimum bending radius 8 cm. When connected care should be taken not to bend or break any of the 26 pins.

3.6. Thermal Management

To ensure operation within given specifications and for the warranty to be valid, the laser head must be attached to a heat sink providing adequate thermal resistance. The required thermal resistance for low power models is <0.6 K/W and <0.4 K/W for high power models (i.e Calypso 100 mW, Samba 300 mW, Samba 400mW, Jive 200mW, Mambo 100mW, Flamenco 100 mW, and Rumba 400 mW). This value is the difference between the maximum allowed laser head base plate temperature (50°C) and the maximum specified ambient temperature at the air-heatsink interface (40°C), divided by the maximum power dissipated from the (15W or 25W depending on laser model, see specification below). The mounting surface should be flat within ± 0.05 mm over mounting surface. It is recommended to use a thermal heat compound between the laser head and the heat sink to provide good thermal contact. The Cobolt 'HS-03 Laser Head Heatsink' meets these requirements, see www.cobolt.se for more information on heat sinks. For assistance in thermal management and system integration, please contact Cobolt technical support.

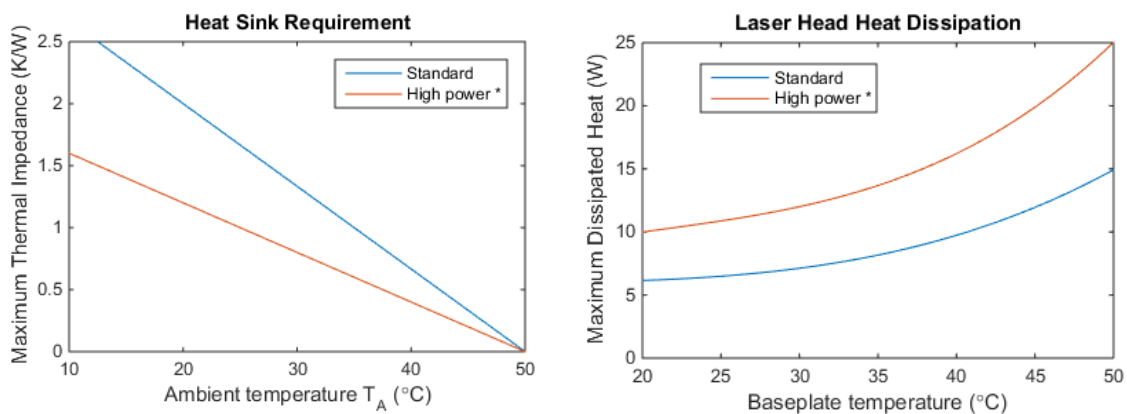

Heat Sink Requirements and typical maximum heat dissipation for Cobolt o4-o1 Series. *High power applies to the following models only: Calypso 100 mW, Samba 300 mW, Samba 400 mW, Jive 200 mW, Mambo 100mW, Flamenco 100 mW, and Rumba 400 mW

3.7. Power Supply Requirements

An appropriate Power Supply Unit (PSU) is supplied by Cobolt with the laser and must be plugged into a properly grounded standard power outlet. The output from this PSU is 12 VDC/5 A. The power supply accepts 100 – 240 V AC and 50-60 Hz. Ripple and noise 1% peak-peak max, 20 MHz bandwidth. The accepted voltage range is 11 V - 28 VDC.

4. System Description

The information presented here is believed to be accurate and is subject to change without notice. The specifications contained herein cannot be guaranteed outside of normal operational conditions. The output power can be adjusted using control commands, see Section 7.4. Specifications are guaranteed at 100% of nominal power.

4.1. Specification

4.1.1. Optical Specifications Free Beam Laser head version 04-01 and 04-51

	Centre wavelength (nm)*	Output power (mW)
Twist™	457.0 ± 0.3	25, 50
Blues™	473.0 ± 0.3	25, 50
Calypso™	491.5 ± 0.3	50, 75
Fandango™	514.4 ± 0.3	50, 100, 150
Samba™	532.1 ± 0.3	50, 100, 150, 200, 300, 400
Jive™	561.2 ± 0.3	50, 75, 100, 150, 200
Mambo™	593.6 ± 0.3	50, 100
Flamenco™	659.6 ± 0.3	100
Rumba™	1064.2 ± 0.6	400

Product Wavelength (nominal)	457	473	491	514	532	561	594	660	1064
Noise 20 Hz – 20 MHz (pk-pk)	<2%		<3%	<2%			<3%	<1%	
Noise 20 Hz – 20 MHz (rms)	<0.25%		<0.3%	<0.25%			<0.3%	<0.1%	
Long-term power stability (8 hours)	<2%		<3%	<2%			<3%	<2%	
Beam divergence (mrad, full angle, 1/e ²)	1.2						1.3	1.5	1.6
Spatial mode	TEM ₀₀ , M ² <1.1								<1.2
Spectral linewidth	<1 MHz								
Coherence length	>100 m								
Beam diameter at Aperture (µm, 1/e ²)	700 ± 50								1000 ± 50
Wavelength stability (after warm-up)	1 pm over ± 2 °C and 8 hrs								
Beam symmetry at aperture	>0.95 : 1								
Polarization ratio (linear, vertical)	>100:1								
Beam pointing stability (after warm-up)	<10 µrad/°C (over 10-40°C)								
Beam waist location (from exit window)	± 20 cm								
Beam angle accuracy	<5 mrad								
Beam position accuracy	<0.25 mm								
Residual IR emission	< Class 1								

* The wavelength is fixed with this accuracy, while drift is defined as Wavelength stability. The wavelength is specified in air.

4.1.2. Optical Specifications Fiber Pigtailed Laser head version 04-03 and 04-53

Product Wavelength	457	473	514	532		561	594	660	1064
Maximum Power out of Fiber (mW)	25	25 35	25 50 100	25 50 100	150* 200*	25 50 75 100*	25 50 75	50*	200*
Fiber end-cap	Yes		No		Yes	No			
Power stability (8 hrs \pm 3°C)	< 3 %								
Mode Field Diameter (μm)*	3.5		4.0				4.5	6.6	
Fiber Output	FC/APC, 8°, non-collimated								
Fiber Type	SM/PM								
Polarization	PER > 100:1, \pm 2°								
Standard Fiber Length	1 m								
Jacketing	\varnothing 3mm, Stainless Steel								
Available configuration	OEM or CE/CDRH								

* Wavelength and power level only available as model 04-53.

** MFD is measured at the nominal wavelength for the fiber (400 nm, 480 nm, 630 nm and 980 nm respectively). The tolerance on the MFD is \pm 0.5 μm

4.1.3. Operation and Environmental Specifications

Power supply	12 VDC, 5 A (11-28 VDC accepted)
System power consumption (Laser Head + Controller)	<25 W (typical ~15 W), < 35 W (typical ~25 W) *
Maximum heat dissipation of Laser Head	<15 W (typical ~10 W), < 25 W (typical ~15 W) *
Maximum Laser Head baseplate temperature	50°C
Warm-up time, from OFF	<2 min
Ambient temperature, operation	10 - 40°C
Ambient temperature, storage	-10 -> +60°C
Humidity	0-90% RH non-condensing
Ambient Air pressure	950-1050 mbar
Heat sink thermal resistance, Laser Head	<0.6 K/W <0.4 K/W *

* Applies to high power models: Samba 300 mW, Samba 400mW, Jive 200 mW, Mambo 100mW, Flamenco 100 mW, Rumba 400 mW

4.1.4. Electrical Interfaces

Interfaces	Connector	Function
Input power	Kycon KPJX-45, 4-pin	Power supply to Controller
Laser Head to Controller	HD-sub 26-pin, male	Connection to Laser Head
Controller to Laser Head	HD-sub 26-pin, female	Connection to Controller
Data port	USB-type mini B	Control and monitoring via control commands
Remote interlock &	Molex 90130-3206	Analog input 5 – 12 V => Laser ON

Analog signals		Analog input <2.7 V => Laser OFF
Warm-up time		2 min

4.1.5. Mechanical Interfaces

Dimensions:	
Laser Head o4-01/o4-51	102x60x40 mm (4.0x2.4x1.8 inches)
Laser Head o4-03	117x60x45 mm (4.6x2.4x1.8 inches)
Controller	190x72x28 mm (7.5x2.8x1.1 inches)
12V PSU	132x58x30 mm (5.2x2.3x1.2 inches)
Fixation holes, Laser Head	∅ = 4x 4.5mm (M4) ; 115mm x 55mm
Fixation holes, Controller	∅ = 4x 6.4mm (M6) ; 178mm x 51mm
Cable (Laser Head – Controller)	1 m length, >8 cm bending radius
Laser head weight	< 0.5 kg

4.2. Mechanical Drawings

4.2.1. Laser Head o4-01 and o4-51

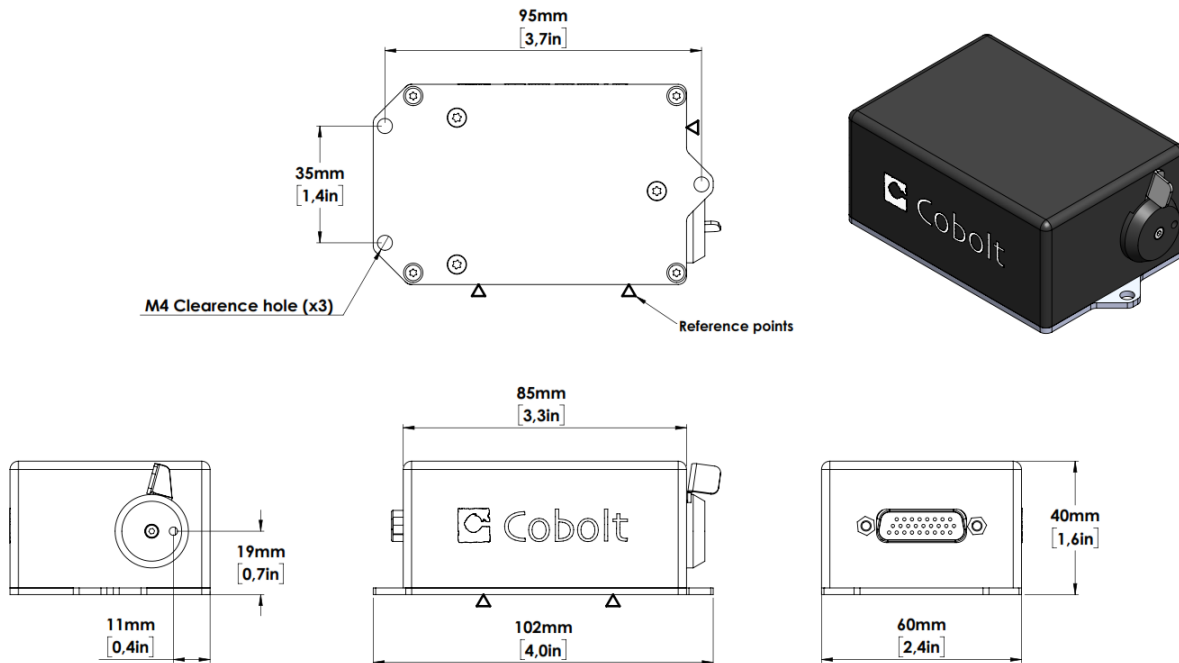

Free Beam Laser head mechanical outline. Dimensions in mm [inches].

4.2.2. Laser Head o4-11 (OEM Only)

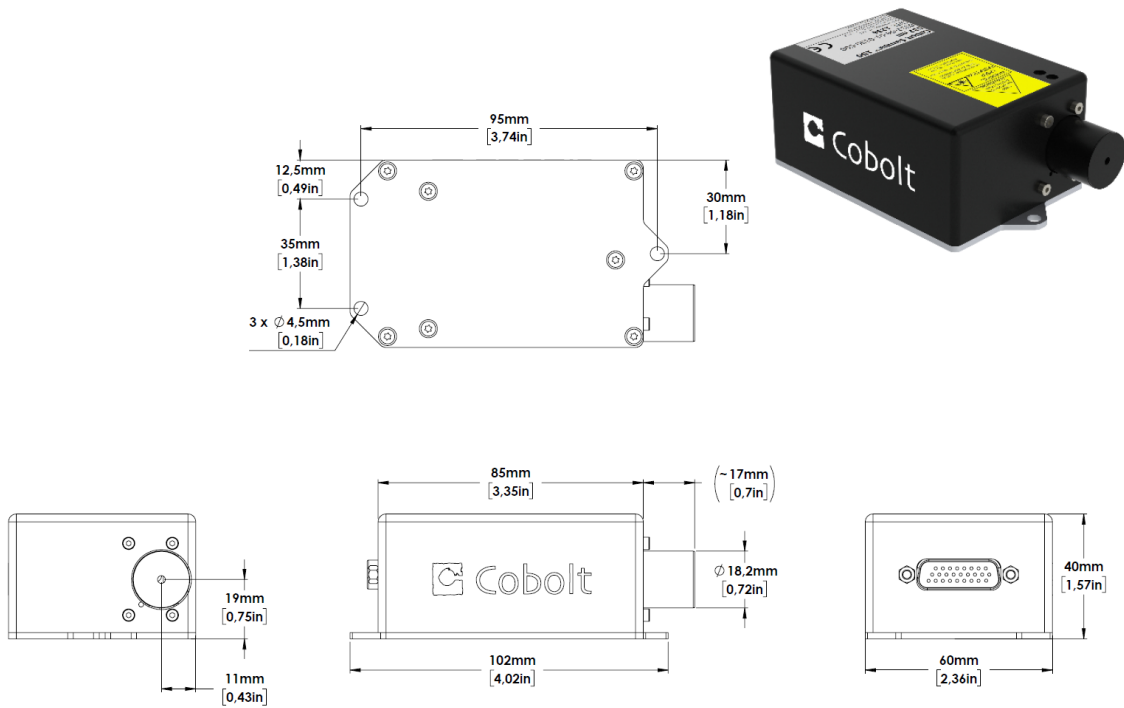

4.2.3. Laser Head o4-01 and o4-51

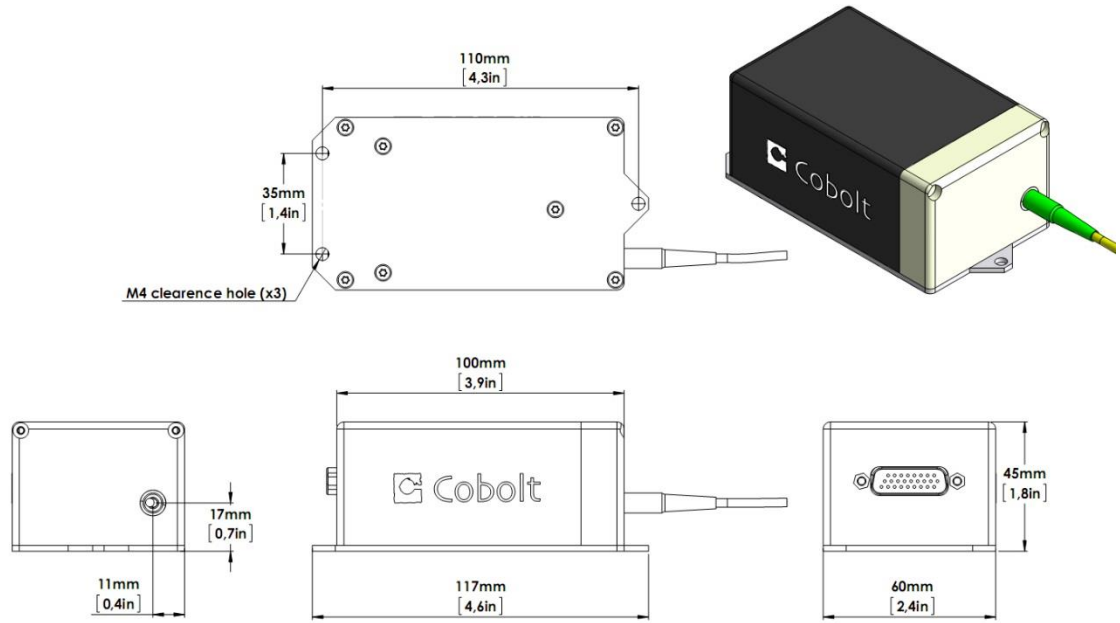

Fiber Pigtailed Laser head mechanical outline. Dimensions in mm [inches].

4.2.4. Controller

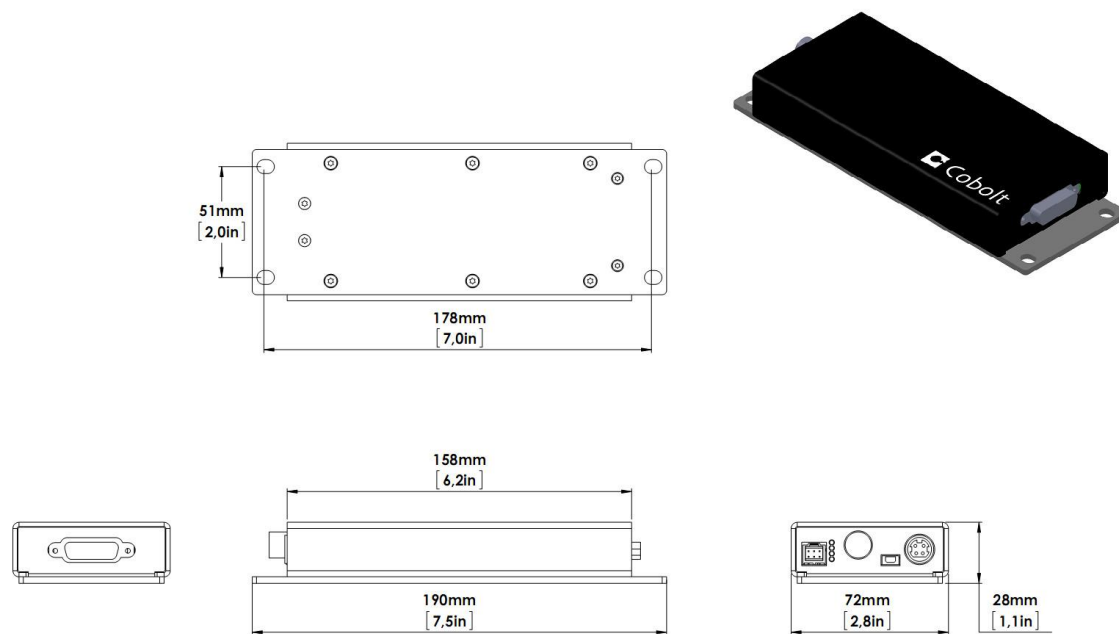

Controller mechanical outline. Dimensions in mm [inches].

4.3. Remote Interlock Connector

The remote interlock connector is located at pin 1 and 2 of the molex connector on the Controller. The connector can be short-circuited with an interlock jumper (included at delivery) for operation of the laser. To use the remote interlock connector with an external switch, connect a pin 1 and 2 on a Molex plug. After the remote interlock connector has been opened the laser will need to be reset by disconnecting from and then reconnecting to the power supply in order to start again. Alternatively, it can be re-started using a special sequence of commands, see Section 7.4 for further details. The signal level is between 0V and +5V with a pull up resistor, and the current required to ground the remote interlock connector is 5 mA. The time delay in the hardware is <1ms, but after filtering by the firmware the reaction time is extended to < 20ms.

4.4. Direct ON/OFF control

The Direct On/Off Control feature enables turning the laser ON/OFF using a 5-12 VDC signal. After having configured the Controller for Direct Control operation (factory set or by executing @cobasdr 1), the laser can only start-up when 5-12V VDC (max 12.5 VDC) is applied to pin 3 on the analog connector with 0 VDC on pin 2 as reference. Shifting the signal to 0 VDC on pin 3 will turn the laser off and put the laser in stand-by mode (status LED:s is POW and not flashing).

This function is not available for CDRH compliant models.



NOTICE This input only controls the on/off state of the laser and cannot be used to modulate the power output. Integrated or externally mounted modulation solutions are available for most wavelength and power combinations, see www.cobolt.se for more information. a

4.5. Pin assignment

All equipment connected to the system should be limited energy as described by IEC 61010:1.

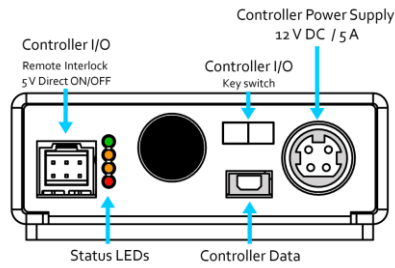

4.5.1. Analog connector & Remote interlock connector

Manufacturer Molex 90130-3206, mates with 90143-0006.

Pin	Function
1	Remote Interlock (connect to pin 2 for enable)
2	0 V - GND
3	Remote On/Off (+5V Input)
4	TST (Internal Cobolt use only)
5	LED "Laser on" (5V)
6	LED "Error" (5V)

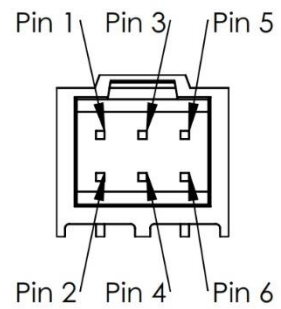

4.5.2. Power connector

Kycon KPJX-4S, mates with Kycon KPPX-4P. Grounded shield.

Pin	Function
1	0 V
2	+11-28 VDC
3	0 V
4	+11-28 VDC

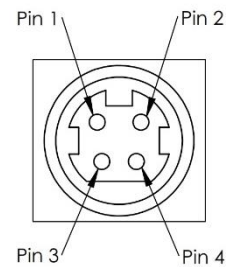

4.5.3. Data connector

Connector USB-type, manufacturer Hsuan Mao C8320-05BFDSBo, mates with connector mini-B.

Pin	Function (USB)	Function (RS-232)
1	+5 V	Not connected
2	D-	RS-232_TX
3	D+	RS-232_RX
4	Not connected	Not connected
5	0 V (GND)	0 V (GND)

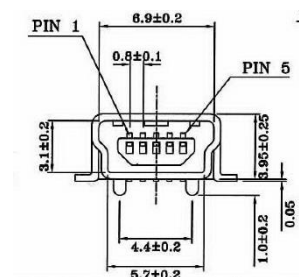

5. Operating Instructions

As standard, all lasers are delivered with the Controller set in Auto-start mode. As soon as power is supplied to the Controller the temperature control elements are operating to reach set-point values and the laser emission will start, unless the key-switch is enabled (CDRH model).

5.1. Installation start-up operation

1. Mount the laser head on a suitable heat sink (see Section 3.6).
2. Ensure that the remote interlock jumper is connected.
3. Connect the laser head to the Controller with the Cable and fasten screws at both ends.
4. Connect the 12 VDC power supply to the mains outlet and then to the Controller.
5. The laser now goes through the following auto-start sequence:
 - Temperature stabilization (1-2 min). Status LEDs: POW flashing, then POW goes on.
 - Turn key switch to start the laser. Status LEDs: ON goes on (CDRH model only)
 - The laser starts (light is emitted) in a constant warm-up current constant for 60 sec. Status LEDs: ON goes on.
 - The laser locks to pre-set output power (<2 min) and operates according to specifications. Status LEDs: LOCK goes on.

If the power does not match the power as stated on the test sheet see Section 11 : Service for more information.

5.2. Shutdown procedure operation

1. Turn the key switch to OFF first (CDRH models only).
2. Disconnect PSU from mains outlet.
3. Disconnect Controller from PSU.

6. Operating Modes

There are two operating modes: constant power and constant current. The default mode for Cobolt o4-o1 series lasers when shipped is constant power. In constant power mode the power is monitored on an internal photodiode, and this is used to regulate the current to maintain a constant power level. In constant current mode the laser runs at a set current level.

7. Operation via data port

To communicate with a Cobolt o4-01 lasers use the mini-USB data port on the external controller. The appropriate communication cable is provided with all lasers. Determine which communication protocol (USB or RS-232) your system is configured for by either checking the label on the mini-USB data port or from the model number (see 3.1).

7.1. Handshaking

Under no circumstances does the system initiate communication; it only transmits characters in response to a message. Every message generates a response, either a numerical value or the acknowledgment string "OK". In the event that the system receives a message that it cannot interpret, it responds: "Syntax error: illegal command". Every system response is terminated by a carriage return (ASCII 13) and a full stop is used with floating numbers.

7.2. RS232 communication

Cobolt o4-01 laser controllers are configured for either RS-232 or USB configuration. The system is shipped from the factory with a fixed baud rate (115200). The other serial port parameters are: 8 data bits, 1 stop bit and no parity. Hardware flow control is not supported. Each command must be terminated by a carriage return. All commands are case-sensitive. Leading and trailing white space is ignored, but command arguments must be delimited by a single space character (ASCII 32).

7.3. USB communication

To support USB communication, the appropriate USB driver will be automatically installed on the computer with Windows 10 and up, when the laser is connected for the first time. If a computer with another or older operating system is used, then the USB driver must be actively downloaded from the Hübner Photonics website (<https://hubner-photonics.com/>).



NOTICE If using an RS-232 configured Cobolt o4-01 laser, do not install any USB driver, regardless of operating system.

7.4. Communication commands

The laser is delivered set in Auto-start mode (see section 5.1 for Auto-start sequence description). As long as DC power is supplied to the system the temperature control elements are always operating to reach set-point values and the laser will be idle waiting for the next command. All arguments are in lower case and separated by a space (ASCII 32). For more information during system integration contact your local sales representative.

Command	Function	Argument	Returned value
l?	Get laser ON/OFF state		0 = OFF 1 = ON
@cob1	Laser ON Starts the laser via a fixed warm-up phase (nominal 60 sec) with constant drive current, even if Auto-start mode has been disabled.		
l0	Laser OFF		
p?	Get set output power		Power (W)
p	Set output power	Power (W)	
pa?	Read output power		Power (W)
i?	Get drive current		Current (A)
cp	Enter constant power mode		
ci	Enter constant current mode		
slc	Set drive current	Current (A)	
ilk?	Get interlock state		0 = interlock closed (OK) 1 = interlock open
leds?	Status of 4 LEDs		Int [0:15] Bit 0 = "POWER ON" Bit 1 = "LASER ON" Bit 2 = "LASER LOCK" Bit 3 = "ERROR" 1 = LED on 0 = LED off
f?	Get operating fault		0 = no fault 1 = temperature error 3 = open interlock 4 = constant power fault
cf	Clear fault		
sn?	Get serial number		Serial number
hrs?	Get system operating hours		Operation hours

For re-starting the laser with commands after having opened the remote interlock switch, execute "cf" for clear fault followed by "@cob1" to restart the laser. For CDRH models, toggling the key switch is the only way to re-start.

8. Cobolt Monitor™ Software

The Cobolt Monitor™ software provides a graphical way to monitor the laser performance and to change power, operation mode and other settings. The software can connect to the laser either via RS-232 port or via USB, depending on the system configuration. When using Cobolt Monitor™ with Windows 10, the USB device is automatically detected. When using Windows 8 or earlier the USB driver must be installed manually and can be downloaded from the Cobolt website (<https://hubner-photonics.com/>), see section 7.3.

Cobolt Monitor™ has been tested with operative systems Windows 10, Windows 7, Windows 8, Windows XP and Vista. Microsoft .NET 2.0 is required to run the Cobolt Monitor™ software. Most computers with operative systems have this included as standard.

8.1. Installation

Download the latest version of the Cobolt Monitor™ software from <https://hubner-photonics.com/>. The Cobolt Monitor™ software is a stand-alone executable, the executable file is packaged with other files needed to run the program in a .zip file. Save the .zip file and extract all files. The folder created after extracting the files can be placed on any storage device and Cobolt Monitor™ can be run from there. All files and folders contained in the .zip file must be present for the program to function properly.

8.2. Software instructions

The software automatically searches for Cobolt devices every 5 seconds and automatically connects the laser if detected. The software can identify USB connected lasers as well as RS232 connected lasers.

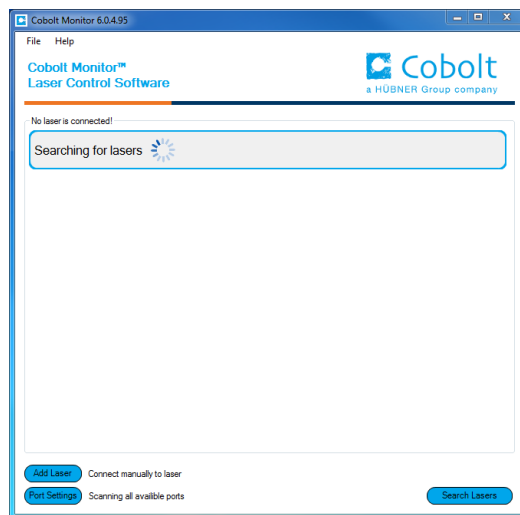

The first Cobolt Monitor™ window that appears in the Cobolt Monitor software.

Once the laser is connected it can be controlled from the box dedicated for the laser. The interface, found in the following figure, is intended for typical user cases. Only the relevant information is presented on this level, displaying only the status the laser is in and relevant choices to make. Here follows a short description of how to use the Cobolt Monitor™ software on this level.

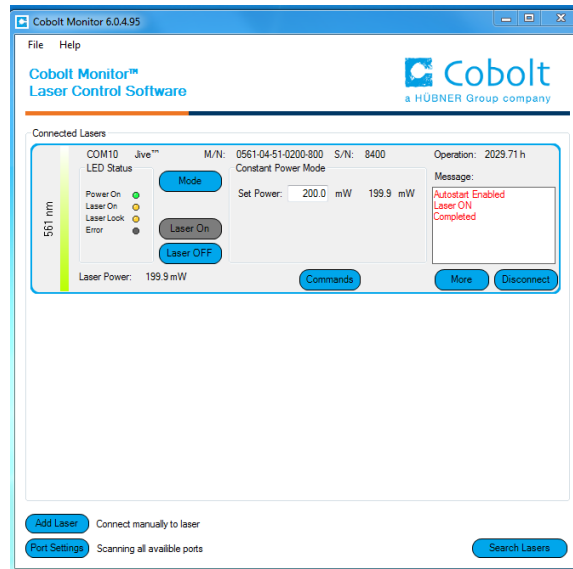

Laser successfully connected.

Laser ON – Turns the laser ON. If the laser is in autostart mode this is equivalent to “restart”.

Laser OFF – Turns the laser OFF.

Mode – Gives a choice of operational modes possible to choose for the laser model. For o4 series lases Constant Power or Constant Current operation can be chosen. Only relevant choices are presented to the mode of operation chosen.

Commands – opens a command communications window to send commands directly to the laser controller.

Message – highlights important information of the laser status to the user.

Disconnect – allows the user to disconnect from the Cobolt Monitor™ software in a controlled way.



NOTICE The communication cable should not be removed when the software is in connect state. The communication within the controller may then malfunction and this might require a power restart of the driver. To disconnect the laser click “Disconnect” or close Cobolt Monitor™ completely. It is also possible to disconnect by powering the laser OFF. In this case Cobolt Monitor™ will automatically close the window for that laser.

Clear Fault - is displayed in the event of a fault. The user can deal with the cause of the fault and then press “Clear Fault” and then restart the laser by clicking “Laser ON”. Example: if the remote interlock loop is open the user must make sure the loop is closed again before issuing a “Clear Fault” followed by “Laser On”.

More –an additional Cobolt Monitor™ window will open containing more detailed information of that laser’s status.

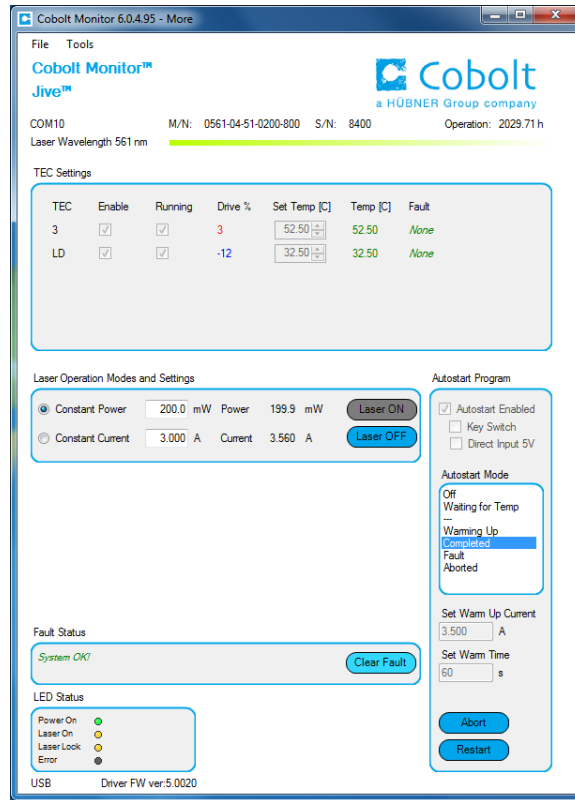

Cobolt Monitor™ software expanded to for more detailed monitoring.

TEC Settings – shows the running status and the fault status for the laser’s internal thermoelectric coolers (TEC).

Laser Operation Mode and Settings - displays the set laser power. The user can switch between constant power mode and constant current mode. Likewise, there are boxes to set the constant power level and constant current level. The output power (as monitored measured on an internal photodiode) and the current through the laser pump diode are both displayed.

Autostart Program - displays whether the laser is in CDRH or OEM mode and displays the current laser operational status. 5V direct input is set here, see section 4.4. There are also buttons to “abort” the autostart sequence or to “restart” the laser after a fault.



NOTICE Specifications are only guaranteed in constant power mode, at 100% of nominal power.

Fault Status – displays ERROR messages. In the event of an ERROR, the laser action is stopped. When the reason for the ERROR event is understood and the problem is addressed the fault status can be cleared with “Clear Fault”. If the Autostart Program is enabled, click restart to restart the laser.

LED Status - displays the LEDs that are currently illuminated on the Controller, see section 3.4. These are displayed even if the laser is in OEM mode.

9. Troubleshooting

In the unlikely case of a problem occurring, use the table below to help identify the error. Some faults can be fixed remotely. Back reflections into the cavity can cause instability of operation. Isolators are available as an option. In case of a sudden voltage drop the laser will turn itself off and restart. If it is in CDRH configuration it will require that the key is turned on again. Contact Cobolt support or your local representative to identify corrective action.

LEDs	Status	Explanation	Action
	off flashing		
POW	x	Mains power off	Check connections
POW	x	Temperatures not stabilized	Check if heatsink is sufficient
LOCK	x	Laser cannot lock in constant power current limit has been reached	Check for back reflections. Contact the factory.
ERROR	on	Error in laser parameters	If lights at start-up check cable connections, if li >5s after start-up contact the factory.

10. Warranty and Maintenance

Cobolt provides a warranty of 24 months after delivery, with unlimited number of operation hours on all Twist™, Blues™, Fandango™, Samba™, Jive™, Mambo™, Flamenco™ and Rumba™ 04-01 laser systems. Cobolt provides a warranty of 24 months or 5000 hours after delivery on the Cobolt Calypso™ 04-01 laser systems. The warranty on the fiber pigtailed (04-03) option is 12 months on faulty workmanship (24 months on the laser itself).

The laser systems are designed for modular repair or replacement in the event that the laser head or Controller malfunctions. Warranty is invalid if the laser system is operated outside of the specific limits and conditions as outlined in this document. The Cobolt lasers are contained in sealed enclosures and should not be opened for any reason. Disassembly of any part of the system (including the cable) means the system no longer complies with the EMC standards will void the warranty. All laser parameters are set at the factory, and there are no adjustments required. Maintenance is limited to wiping dirt off the enclosures and cleaning the aperture.

11. Service

Due to accuracy tolerances, calibration differences and allowed power drift there may be discrepancies between the Cobolt measurement of the optical output power and the customer measurement equipment. If the output power deviates from the reported value please contact your local Cobolt representative for an online re-calibration. If the laser does not function, do not attempt to open any of the units, or the warranty will be voided. Contact your local Cobolt representative for consultancy and to request an RMA number (see back cover for contact information). If an RMA number is issued and the laser needs to be shipped back to Cobolt or your local representative, please pack the complete system for shipment using the original package or equivalent. Ensure the unit is free from thermal paste before packing. The warranty covers repair or replacing the unit at the option of Cobolt.

12. Compliance (CDRH models only)

The CDRH model lasers (-3/5/700) are designed and manufactured to comply with the EC Low Voltage Directive and the EC EMC Directive in the CDRH-compliant configuration of laser head, 1 m controller cable, controller, key and Cobolt-supplied power supply. All equipment must be mounted on a common ground plane, such as an optical table. If any part of the delivered equipment is replaced with a part not supplied by Cobolt or if the equipment is not properly grounded, the system may not conform to CE / CDRH compliance standards listed in section 12. Disabling any of the safety features nullifies the CE marking and violates the laser safety standard.



The following harmonized and limits standards have been applied:

Electrical Safety	EN 61010-1, IEC-61010-1, UL 61010-1 (Limited Energy System) UK S.I. 2016 No. 1101 : The Electrical Equipment (Safety) Regulations 2016
Laser Safety/Class	IEC-60825-1 FDA / CDRH : Complies with 21 CFR 1040.10 and 1040.11 except for conformance with IEC 60825-1 Ed. 3., as described in Laser Notice No. 56, dated May 8, 2019.
EMC	IEC 61326-1 EN 55011 Electromagnetic Emission , Class A Electromagnetic Immunity – Table 1 Requirements EN 61000-4-2 Electrostatic Discharge ±4 kV contact discharge and ±2 kV, ±4 kV, ±8 kV air discharge EN 61000-4-3 Radiated electromagnetic fields 80 – 1000 MHz, 3 V/m with 80 % AM @ 1 kHz 1.4 – 2.7 GHz, 3 V/m with 80 % AM @ 1 kHz EN 61000-4-4 Fast transient / Burst AC Power input port ±2,0 kV EN 61000-4-5 Surge AC Power input port ±0,5 kV, ±1,0 kV, ±2,0 kV Com. Mode AC Power input port, ±0,5 kV, ±1,0 kV Diff. Mode EN 61000-4-6 Conducted Immunity 3 V with 80 % AM @ 1 kHz EN 61000-4-11 Dips and Interruptions 50 Hz and 60 Hz. Test voltages: 100 V and 230 V UK S.I. 2016 No. 1091 : Electromagnetic Compatibility Regulations 2016 FCC 47 CFR - Part 15 (2009): Subpart B, Class A
RoHS	EU Directive 2011/65/EU, EU 2015/863 and amendment EU 2017/2102 UK S.I. 2012 No. 3032

Contact your sales representative for a copy of the full Declaration of Conformity.

13. Disclaimer

Cobolt will assume no responsibility for damage incurred by faulty customer equipment, such as measurement equipment, cables etc, used in conjunction with Cobolt lasers. Cobolt makes no warranty of any kind with regard to the information contained in this guide, included but not limited to, implied warranties of merchantability and suitability for a particular purpose. Cobolt shall not be liable for errors contained herein nor for incidental or consequential damages from the furnishing of this information. No part in this manual may be copied, reproduced, recorded, transmitted, or translated without the express written permission by Cobolt.



Our Locations

Cobolt AB

(Sales in Norway, Sweden, Finland and Denmark)

Solna, Sweden

Phone: +46 8 545 912 30

Fax: +46 8 545 912 31

E-mail: info@coboltlasers.com

HÜBNER Photonics GmbH

(Sales in Germany, Switzerland and Austria)

Kassel, Germany

Phone: +49 561 994 060-0

Fax: +49 561 994 060-13

E-mail: info.de@hubner-photonics.com

HÜBNER Photonics Inc.

(Sales in USA, Canada, and Mexico)

San Jose, California, USA

Phone: +1 (408) 708 4351

Fax: +1 (408) 490 2774

E-mail: info.usa@hubner-photonics.com

HÜBNER Photonics UK

(Sales in UK and Ireland)

Great Britain

Phone: +44 735 944

E-mail: info.uk@hubner-photonics.com

www.hubner-photonics.com

HÜBNER Photonics

