

Cobolt Tor™ XE

High Performance | Triggerable | Q-Switched Lasers

1064 nm

532 nm



HÜBNER Photonics



CONTENTS

1.	Introduction	5
2.	Safety	6
2.1.	General	6
2.2.	Beam Hazards	7
2.3.	Safety features	8
2.4.	Equipment Safety	8
2.5.	Warning and Identification Labels	9
3.	Start-up Instructions	10
3.1.	Installation start-up operation	10
3.2.	Shutdown procedure operation	11
4.	Cobolt Monitor™ Software	12
4.1.	Installation	12
4.2.	Software instructions	12
5.	Overview	16
5.1.	Model number	16
5.2.	Configuration	17
5.3.	Laser Head	17
5.4.	Thermal Management	18
5.5.	Power Supply Requirements	19
6.	System Description	20
6.1.	Specification	20
6.2.	Mechanical Drawings	23
6.3.	Remote Interlock Connector	24
6.4.	Direct Input control	24
6.5.	Pin assignment	25
7.	Operating Instructions	28
7.1.	Internal and External Triggering	28
7.2.	Pulse Monitor Output	32
8.	Operation via data port	33
8.1.	Handshaking	33
8.2.	USB driver	33
8.3.	Communication commands	36
9.	Troubleshooting	38
10.	Warranty and Maintenance	40
11.	Service	40
12.	Compliance (CDRH models only)	41
13.	Disclaimer	42

1. Introduction

The HÜBNER Photonics Cobolt Tor™ XE lasers are high performance, triggerable, air-cooled, nanosecond pulsed lasers. The sophisticated cavity design of these lasers provides short pulse length and exceptional pulse-to-pulse stability in a high quality TEM₀₀ beam.

The lasers are manufactured by Cobolt AB at the Swedish production facility. Cobolt AB is a part of HÜBNER Photonics. Using proprietary HTCure™ technology the lasers are packaged into a sealed laser head, offering an outstanding level of robustness and reliability, and making these lasers highly suitable for OEM integration into demanding environments.

The combination of compact format, high level of robustness, high peak power and pulse energy performance make the Cobolt Tor™ XE lasers ideal light sources for a large variety of industrial and scientific applications, including LIBS, micro-dissection, MALDI-TOF, range-finding, Raman-LIDAR and micro-machining.

2. Safety

2.1. General

Cobolt Tor™ XE lasers are Class 4 (IEC) laser products that emit laser radiation in the Near Infrared (NIR) spectrum and Class 3B in the visible spectrum. Residual emissions from the pump diode are contained within the laser head housing via filtering optics. The residual emission does not exceed Laser Class 1.

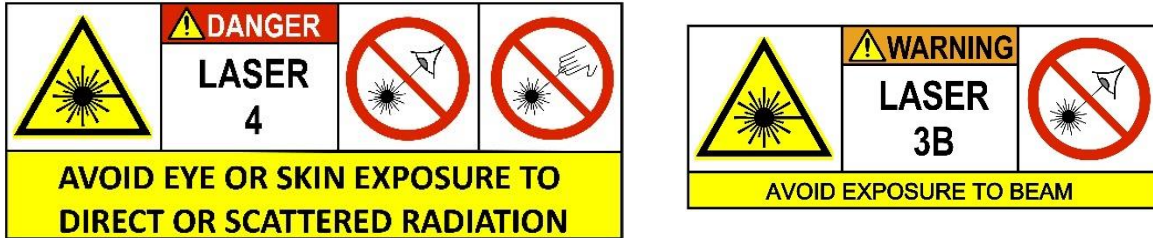

The table below describes the nominal lasers operation parameters.

Product	Average Power (mW)	Pulse Duration (ns)	Pulse Repetition Rate (kHz)	Pulse Energy (µJ)
Cobolt Tor™ XE 1064 nm	500	2.5 ± 1.0	Up to 1 kHz	500
Cobolt Tor™ XE 532 nm	250	2.0 ± 1.0	Up to 1 kHz	250

Symbols in the manual



WARNING – LASER RADIATION This symbol is used to call attention to important laser safety information



WARNING – STATIC MAGNETIC FIELD This symbol is used to call attention to important magnetic field safety information



CAUTION – GENERAL This symbol is used to call attention to important general operator and equipment safety information



NOTICE – GENERAL This symbol is used to call attention to best practices when using the equipment and does not indicate a hazard.

2.2. Beam Hazards

Eye and skin exposure to direct or reflected laser light is hazardous and may be extremely harmful. Always wear eye protection appropriate to the beam wavelength and intensity. Class 4 laser radiation may ignite flammable materials and combustible gases in the beam path and, in event of ignition, fumes may be generated. All equipment used in close proximity to the laser beam should be suitably fire resistant and the facility should be properly ventilated. It is advised to perform a risk assessment for the facility and equipment prior to using the laser. In the case of integration into a larger system, laser safety compliance must be evaluated on the end product.



WARNING Remove all watches, rings, and other reflective jewelry before working with lasers. Always wear the appropriate eye protection suitable for the wavelengths integrated into the system. Verify the accessible emission wavelength and power before operating. **Never look directly into a laser beam.**

The device must be handled by skilled personnel experienced with lasers, in a laboratory environment and with access to adequate laser safety equipment. The laser head clearly displays a yellow warning label that shows the location of the laser beam aperture. This label must be visible unless the laser beam is totally enclosed. If the laser does not function, do not attempt to open any of the units, or the warranty will be voided. Call or e-mail your local sales representative for consultancy and to request an RMA number (see back cover for contact information).



CAUTION Use of controls or adjustments or performance of any procedures other than those specified herein may result in exposure to hazardous radiation.

The table below describes the maximum energy density in J/cm² used for safety calculations and the appropriate level of eye protection in terms of optical density (OD) for each product line.

Product	Laser Class	Warning Label Power (mW)	Max Pulse (mJ)*	Max Energy Density (J/m ²)**	Eye Protection Requirement***
Cobolt Tor™ XE 1064 nm	4 / IV	< 1000	1.0	7074	> OD 4 / D LB6 R LB7
Cobolt Tor™ XE 532 nm	3B / IIIB	< 499	0.49	7074	> OD 4 / D LB5 R LB6

* Max Pulse (μJ) = Warning Label Power (W) ÷ Repetition Rate at bottom tolerance (Hz)

** Max Energy Density (J/m²) = Warning Label Pulse (J) ÷ Beam Area at bottom tolerance (cm²)

*** Eye protection (OD) = Log₁₀(60825-1 Emission Limit : Class 1 (μJ) ÷ Max Pulse (μJ)), rounded up to the next integer/See EN 207

2.3. Safety features

The laser is equipped with all required safety features as described in the laser safety standard 60825-1. Disabling any safety features negate the CE/CDRH compliance of this product. If any part of the delivered equipment is replaced with a part not supplied by , Cobolt, a part of HÜBNER Photonics, or if the equipment is not properly grounded system may not conform to CE / CDRH compliance standards listed in section 12 : Compliance (CDRH models only). Disabling any of the safety features nullifies the CE marking and violates the laser safety standard.

Remote Interlock Connector

The remote interlock connector is a connector which permits the connection of external controls placed apart from other components of the laser product. When the terminals of the connector are open-circuited, emission is interrupted, and no radiation will be accessible. The remote interlock connector permits easy addition of an external interlock in laser installation. See section 6.3 for a detailed description of the remote interlock circuit and operation.

Manual Shutter (Beam Stop)

The laser head is equipped with a manual shutter, which functions as the beam stop, capable of preventing human access to laser radiation. The aperture location and the open versus closed positions of the shutter are indicated on the top surface of the laser head.

Key Control

The CDRH compliant model comes with a key-switch control which must be connected for the laser to operate. When the key is in the OFF position, the laser is prevented from emitting. The key must be actively turned to the ON position each time the laser is powered on. When the key is removed from the system laser radiation is not accessible.

Laser Radiation Emission Warning

The Key control box incorporates information LEDs which display whether power is connected, the laser is on, or a fault has occurred. The "ON" LED is illuminated whenever the device is emitting or could emit light. The emission warning indicators are also visible in the Cobolt Monitor™ software, see Section 4 for details on the control software.

2.4. Equipment Safety

Always install all power supplies used in the laser system to properly grounded power outlets. The laser head must be mounted on a common ground plane, such as an optical table. Cobolt lasers contain a laser diode which is sensitive to electrostatic discharge (ESD).

2.5. Warning and Identification Labels

The upper face of the laser head contains a yellow label with laser safety warning and classification information, the wavelength, maximum pulse energy and average power of the unit. It also shows the location of the laser beam from the aperture and indicates the open and close positions of the manual shutter. This label must be visible unless the laser beam is totally enclosed. A silver label showing information about the laser model, manufacturer date and location, and the power supply voltage and current, is located on the laser head. Lasers shipped to customers in the USA also contain an additional label of CDRH compliance.

Manufacturer Identification Labels

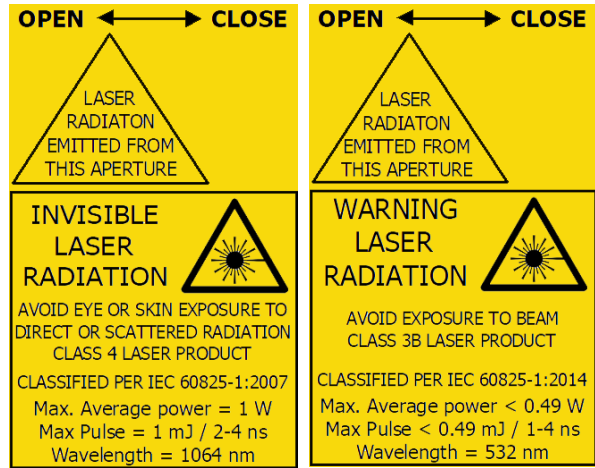
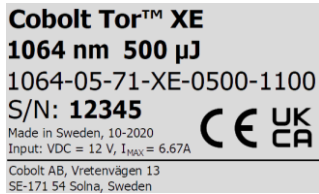
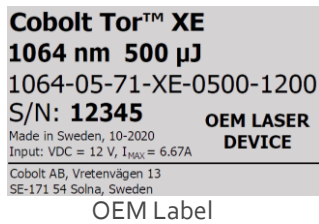

Complies with 21 CFR 1040.10 and 1040.11
 except for conformance with IEC 60825-1 Ed. 3,
 as described in Laser Notice No. 56, dated May 8, 2019.

Laser Notice No. 56 Label
 CDRH models shipped to USA

3. Start-up Instructions

As standard, all lasers set to Auto-start mode upon delivery. As soon as power is supplied to the laser head the temperature control elements are operating to reach set-point values. Cobolt Tor™ XE can be operated either by using the internal trigger source generated by the laser head electronics or by providing an external trigger source, or a combination of both, see Section 7.1 for further instructions. At delivery, the laser is set to operate with the internal trigger source at 1 kHz pulse repetition rate, so the laser emission will start once the temperature control elements have reached their set-point values, unless the key-switch is enabled (CDRH model).

3.1. Installation start-up operation

1. Mount the laser head on a suitable heat sink (see section 5.4)

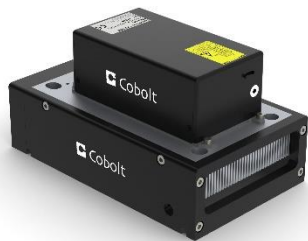

2. Attach the 15-pin D-SUB cable to the CE / CDRH Control Box.



3. Attach the 14 pin Molex connector to the laser head.



4. Insert the interlock plug into the connector on the key control box.



5. Connect the supplied 12V power supply unit to the socket on the laser head and plug it in to the mains.



The laser will go through the auto start sequence (which can be seen in e.g. Cobolt Monitor™ software):

- | | |
|-------------------------|--|
| Waiting for Temp | Laser emission is not enabled until all temperatures have reached their set point |
| Waiting for Key | Toggle the key to proceed, if the key is already in the ON position, turn of OFF and ON again. |
| Completed | The device is emitting or armed for emission. |

6. To start the laser, turn the key on the key control Box clockwise to the ON position. If it is already in the ON position, turn it to OFF and then ON again. The laser will now start up running at 1000 Hz pulse repetition rate.



NOTICE The power and wavelength may continue to drift slightly for up to 5 minutes to reach stable operation.

3.2. Shutdown procedure operation

1. Turn the key switch to OFF first (CDRH models only).
2. Disconnect laser from PSU.
3. Disconnect PSU from mains outlet.

4. Cobolt Monitor™ Software

The Cobolt Monitor™ software provides a graphical way to monitor the laser performance and to control the trigger signal source and the repetition rate. The software can connect to the laser via RS-232 port and via USB, depending on the connector used, see Section 8. When using Cobolt Monitor™ with Windows 10, the USB device is automatically detected. When using Windows 8 or earlier the USB driver must be installed manually and can be downloaded from <https://hubner-photonics.com/>, see section 8.2.

Cobolt Monitor™ has been tested with operative systems Windows 10, Windows 7, Windows 8, Windows XP and Vista. Microsoft .NET 2.0 is required to run the Cobolt Monitor™ software. Most computers with operative systems have .NET 2.0 included as standard.

4.1. Installation

Download the latest version of the Cobolt Monitor™ software from <https://hubner-photonics.com/>. The Cobolt Monitor™ software is a stand-alone executable. The executable file is packaged with other files needed to run the program in a .zip file. Save the .zip file to any storage device and extract all files. The folder created after extracting the files can be placed on any storage device and Cobolt Monitor™ can be run from there. All files and folders contained in the .zip file must be present for the program to function properly.

4.2. Software instructions

The software automatically searches for Cobolt laser devices and automatically connects to the laser when detected. The software can identify USB connected lasers as well as RS232 connected lasers.

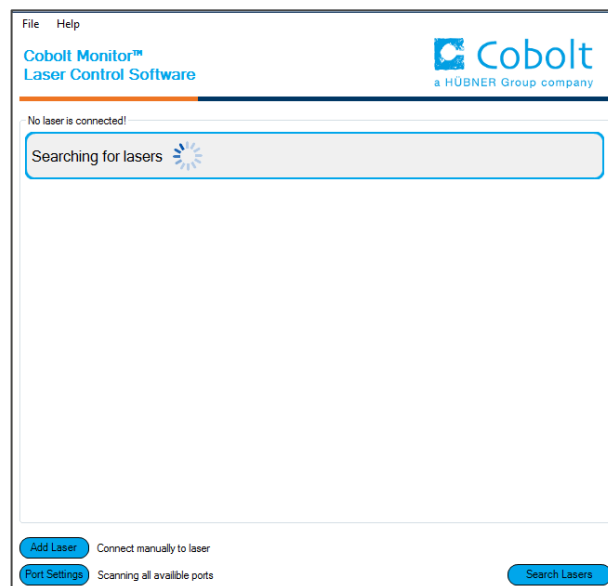

The first Cobolt Monitor™ window that appears in the software.

Once the laser is connected it can be controlled from Cobolt Monitor™ software. Only the most critical information is displayed on this level, including the status of the laser and the possibility to switch the laser ON or OFF. Here follows a short description of how to use the Cobolt Monitor™ software on this level.

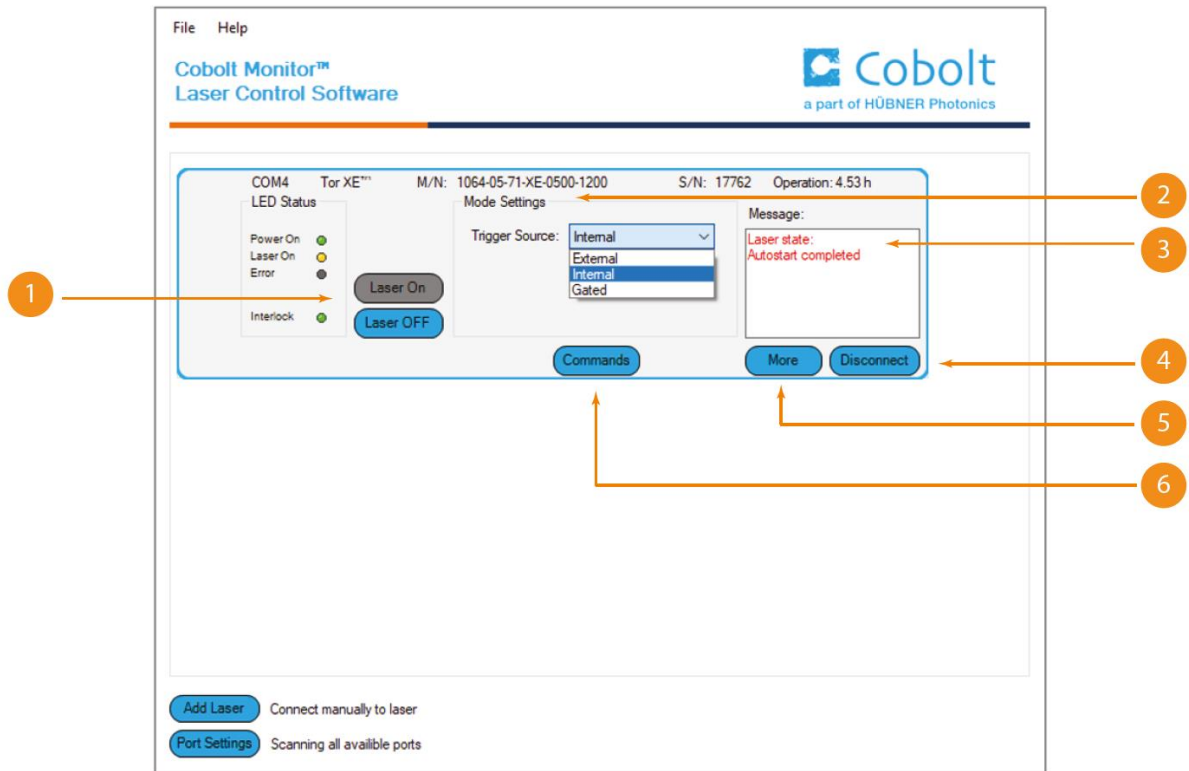

Cobolt Monitor™ Window when the laser is connected.

- 1 ON/OFF** Use these buttons to turn the laser ON and OFF.
- 2 Mode Settings** Can be used to change the trigger signal source between the internal, external, and gated.
- 3 Message** Highlights important information about the laser status to the user.
- 4 Disconnect** Allows the user to disconnect from the Cobolt Monitor™ software in a controlled way.
- NOTICE** The communication cable should not be removed when the software is in connect state. To disconnect the laser, click "Disconnect" or close Cobolt Monitor™ completely. It is also possible to disconnect by powering the laser OFF. In this case Cobolt Monitor™ will automatically close the window for that laser.
- 5 More** Press the 'More' button to open an additional Cobolt Monitor™ window will open containing more detailed information of that laser's status.
- 6 Commands** Opens a command communications window to send commands directly to the laser. See section 8.3 for more details on available commands.

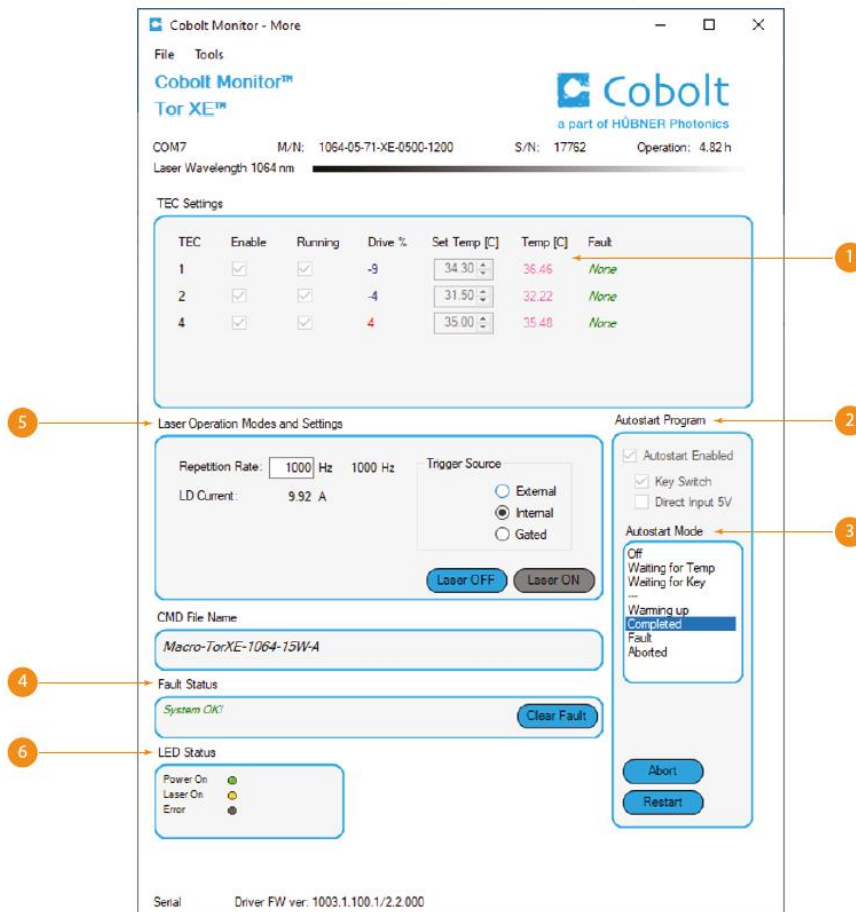

Cobolt Monitor™ software expanded to for more detailed monitoring.

- 1 TEC Settings** Shows the running status and the fault status for the laser’s internal thermoelectric coolers (TEC).
- 2 Autostart Program** Displays whether the laser is in CDRH or OEM configuration and displays the current laser operational status. There are also buttons to “abort” the autostart sequence or to “restart” the laser after a fault.
- 3 Autostart mode**

 - Waiting for Temp** Laser emission is not enabled until all TECs have reached their set point and the TECs are stabilized.
 - Waiting for Key** Toggle the key to proceed, if the key is in the ON position, turn of OFF and ON again.
 - Completed** The device is emitting or armed for emission.
 - Fault** The device has a fault, the fault status must be cleared before the laser can be restarted.
 - Aborted** The autostart sequence has been aborted, but the TECs are still running.

4 Fault Status Displays ERROR messages. In the event of an ERROR, the laser action is stopped. When the reason for the ERROR event is understood and the problem is addressed the fault status can be cleared with 'Clear Fault'. If the Autostart Program is enabled, click 'Restart' to restart the laser.

5 Laser Operation Mode and Settings Displays the set and measured repetition rate of the laser and which trigger signal mode is being used, along with the laser diode current. There are also the buttons "Laser OFF" and "Laser ON" which can be used to turn the laser on or off.

6 LED Status Displays the LEDs that are currently illuminated on the key control box, see section 5.3.1. These are displayed even if the laser is in OEM mode.

Power on	Green	The laser is powered up
Laser On	Yellow	The laser is emitting or armed for emission.
Error	Red	An error has occurred.

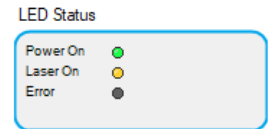

5. Overview

Cobolt Tor™ XE laser systems consist of the Laser Head, the Key Switch box (not shown) and the Power Supply (not shown). Always install the laser system to a properly grounded power outlet. If any part of the supplied equipment is replaced with a part not supplied by the manufacturer or if the equipment is not properly grounded system may not conform to CE / CDRH compliance standards listed in section 12. Disabling any of the safety features nullifies the CE marking and violates the laser safety standard.



5.1. Model number

Cobolt lasers are sold in two configurations: CDRH and OEM, described in section 5.2.1. The model numbers are composed as described below. The Cobolt Tor™ XE lasers are delivered as standard with both USB and RS-232 communication accessible.

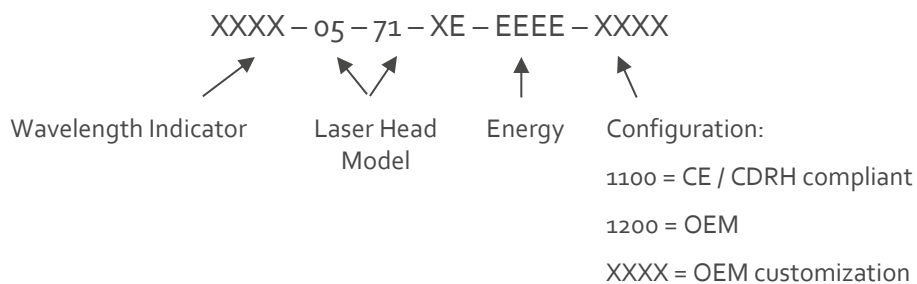

5.2. Configuration

5.2.1. CDRH Compliant

The CDRH compliant system is supplied with a key switch box, which must be connected, along with a remote interlock connector. Once power is supplied, laser radiation starts when the key is turned from the OFF position to the ON position. The status of operation can be monitored via LEDs on the Key Switch box. Setting the key to its OFF position puts the laser in stand-by mode. **The CDRH model is CE compliant.**

The standard CDRH model consists of:

- Laser head
- Key control box
- 14 pin Molex to 15-pin D-SUB cable from laser head to key control box
- Keys
- 12 V / 6.67 A DC power supply unit (Art. Nr. 12522)

5.2.2. OEM

The OEM system is supplied **without** a key switch box. Connecting the power supply to the laser head initiates an automatic start-up sequence. If the remote interlock is connected, laser radiation will start automatically as soon as power is supplied, and internal temperatures controls are stabilized.

The OEM model consists of:

- Laser head
- 12 V / 6.67 A DC power supply unit (Art. Nr. 12522)

5.3. Laser Head

The Laser Head contains a passively Q-switched diode-pumped solid-state laser cavity generating nanosecond pulses and thermoelectric control elements (TEC). The drive electronics is integrated into the laser head. Each laser pulse is triggered, either by the integrated drive electronics or by an external signal through the SMB connector or the 14 pin Molex contact.

The laser beam is not collimated. The laser head also features a manual mechanical shutter, a laser hazard label, and a laser classification label. When power is supplied to the laser head, regardless of direct input or key-switch state, the TECs will be active to reach its set point values.

The mini-USB can be used to communicate with the laser. In addition, the laser head supplies a Molex 14-pin connection, of which the pin 1 and pin 2 are used for the remote interlock function. Pin 4 and Pin 5 can be used to communicate with the laser through RS-232. See section 6.5 for details.

5.3.1. Key control box

The key control box allows the user to operate the laser with a CE/CDRH compliant key-switch. The key control box has LEDs to indicate the laser status. When power is supplied to the laser head, regardless of direct input or key-switch state, the temperature controllers will be active to reach set point values. The key control box also provides the possibility to communicate with the laser using the RS-232 connection.

The status of the laser operation is given via LED indicators:

- ON** Orange Laser emission is on. This light is on in modulation mode if laser emission is possible.
- ERROR** Red An error has occurred.



5.4. Thermal Management

To ensure operation within given specifications and for the warranty to be valid, the laser head must be attached to a heatsink providing a thermal resistance of < 0.15 K/W. This value is the difference between the maximum allowed laser head base plate temperature (50°C) and the maximum specified ambient temperature at the air-heatsink interface (40°C), divided by the maximum power dissipated from the laser, 65 W at high ambient temperatures. The mounting surface should be flat (within ± 0.05 mm over mounting surface). It is recommended to use a thermal heat compound between the laser head and the heatsink to provide good thermal contact. The recommended heatsink for Cobolt Tor™ XE Cobolt 'HS-05 Laser Head Heatsink with fans' meets these requirements, see <https://hubner-photonics.com/> for more information on heat sinks.

For assistance in thermal management and system integration, please contact your local sales representative.

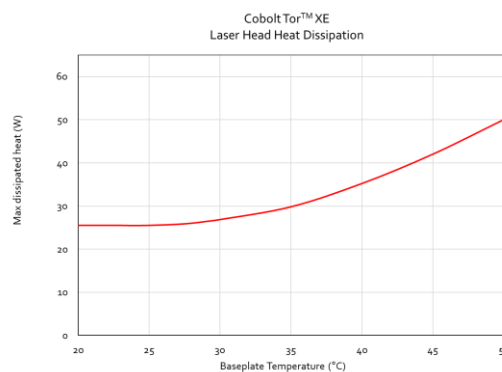
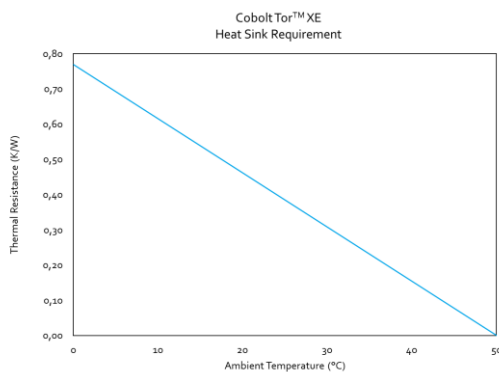

Heat Sink Requirements and typical maximum heat dissipation for Tor XE lasers.

5.5. Power Supply Requirements

An appropriate Power Supply Unit (PSU) is supplied with the laser and must be plugged into a properly grounded standard power outlet. The output from this PSU is 12 VDC / 6.67 A. The power supply accepts 100 – 240 V AC and 50-60 Hz. Ripple and noise 1% peak-peak max, 20 MHz bandwidth. The accepted voltage range is 11.2 V DC– 16.5 VDC; full performance is only guaranteed at 12 VDC / 6.67 A.

The power supply provided with Cobolt Tor™ XE is certified to perform in an ambient temperature of 40°. When integrating this power supply into a larger system care must be taken to ensure that the power supply is not exposed to temperatures above 40°C.

6. System Description

The information presented here is believed to be accurate and is subject to change without notice. The specifications contained herein cannot be guaranteed outside of normal operational conditions. Specifications are guaranteed at 100% of nominal power. The latest specifications can be found at : www.hubner-photonics.com .

6.1. Specification

6.1.1. Optical Specifications

Centre wavelength ¹	1064.2 ± 0.6 nm	532.1 ± 0.3 nm
Pulse energy	500 ± 50 µJ	250 ± 25 µJ
Pulse duration	2.5 ± 1 ns	2.0 ± 1 ns
Repetition rate	Single pulse up to 1 kHz	
Peak power ²	> 128 kW	> 75 kW
Pulse-to-Pulse Jitter	< 2 µs	< 2 µs
Beam Diameter (1/e ²)	700 ± 100 µm	400 ± 100 µm
Beam Divergence	7 ± 1 mrad	5 ± 1 mrad
Beam symmetry at aperture	> 0.85 : 1	
Spatial mode (TEM ₀₀)	M ² < 1.3	M ² < 1.15
Long-term repetition rate stability (8 hours, (±3 °C))	< 3 %	
Pulse-to-Pulse amplitude stability	< 10 %	< 15 %
Beam angle accuracy	< 5 mrad	
Beam position accuracy	< 0.5 mm	
Polarization ratio (linear, vertical)	> 100:1	
Residual emission	< Class 1	

1. The wavelength is specified in air.
2. Assuming a top hat profile, Peak Power (kW) = Pulse Energy (µJ) at bottom tolerance ÷ Pulse width (ns) at top tolerance

6.1.2. External trigger signal specifications

Input trigger frequency	Single pulse to 1 kHz
Input trigger V_{max}	+ 5.0 V
Input trigger V_{high}	+ 3.7 V
Input trigger V_{low}	0 V
Input trigger waveform	Square
Input pulse duration	> 1 μ s

6.1.3. Pulse monitor signal specifications

Pulse monitor Digital signal	TTL (0-1 V)
------------------------------	-------------

6.1.4. Mechanical Interfaces

Dimensions:	144 x 70 x 50 mm (5.67 x 2.76 x 1.97 inches)
Fixation holes, Laser Head	$\varnothing = 4 \times 4.5$ mm (M4) ; 134 mm x 55 mm
Laser Head weight	< 0.62 kg

6.1.5. Operation and Environmental Specifications – Laser Head

Power supply	12 VDC, 6.67 A
Intended use environment	Laboratory (indoor)
Pollution Degree	2
Power consumption, total system	< 60 W
Maximum Laser Head baseplate temperature	50°C
Ambient temperature, operation	10 – 40 °C
Ambient temperature, storage	-10°C to +60 °C
Humidity	0-60 % RH non-condensing
Ambient Air pressure	950-1050 mbar
Heat sink thermal resistance, Laser Head	< 0.2 K/W
Warm-up time, from OFF	< 5 min
Communication protocol	USB and RS-232

6.1.6. Electrical Interfaces

All equipment connected to the system should be limited energy as described by IEC 61010:1.

Interfaces	Location	Connector
Input power	Laser Head	4 pin Molex
To Key control box	Laser Head	CTRL 14 pin Molex 87832-1420 (pin 11)
Remote interlock	Laser Head	OEM: CTRL 14 pin Molex 87832-1420 (pin 1 and 2)
Direct Input	Laser Head	OEM: CTRL 14 pin Molex 87832-1420 (pin 12)
Trigger input signal	Laser Head	SMB
Trigger input signal	Laser Head	CTRL 14 pin Molex 87832-1420 (pin 14)
Pulse monitor output signal	Laser Head	SMB
Data port USB	Laser Head	USB-type mini B
Data port RS-232	Laser Head	CTRL 14 pin Molex 87832-1420 (pin 4 and 5)
To Laser head	Key box	VGA D-SUB 15-pin
Remote interlock	Key box	CDRH: 3.5 mm audio
Data port	Key box	RS-232 Serial D-SUB 9-pin

6.2. Mechanical Drawings

6.2.1. Laser Head

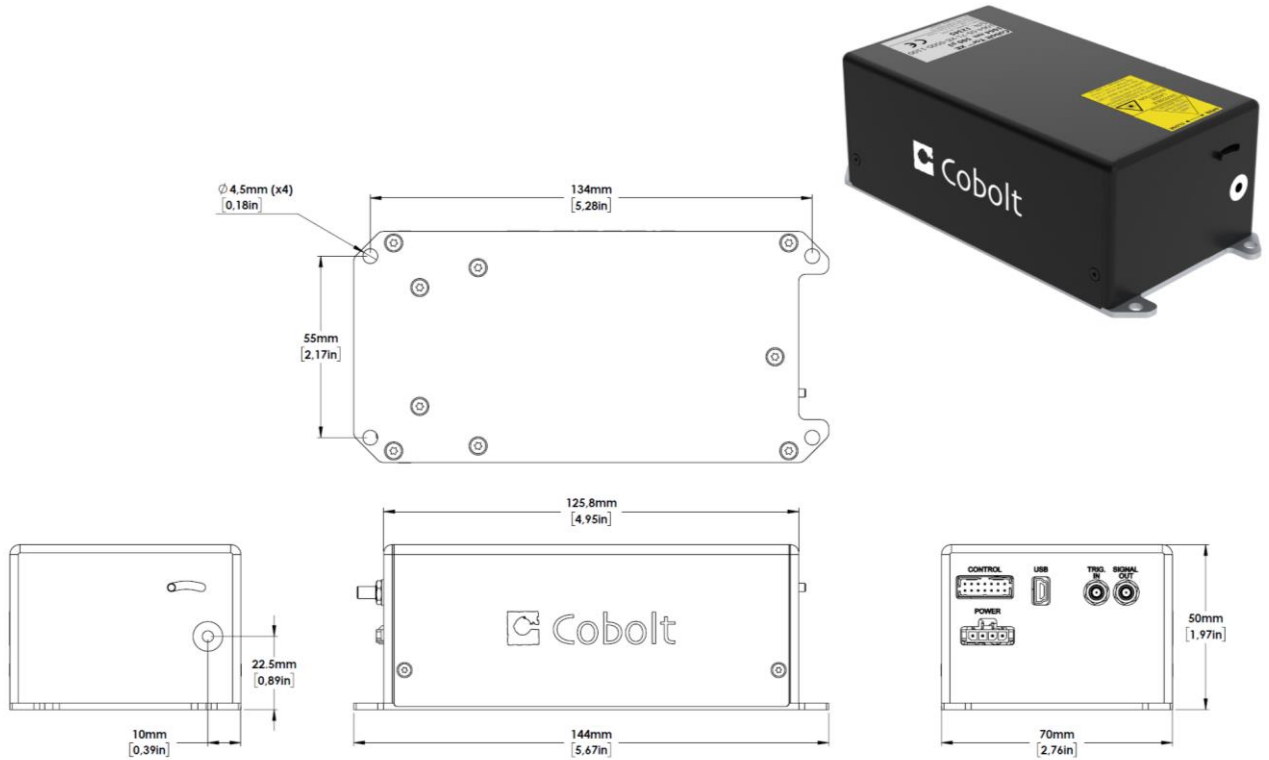

Laser head mechanical outline. Dimensions in mm [inches].

6.2.1. Key control box

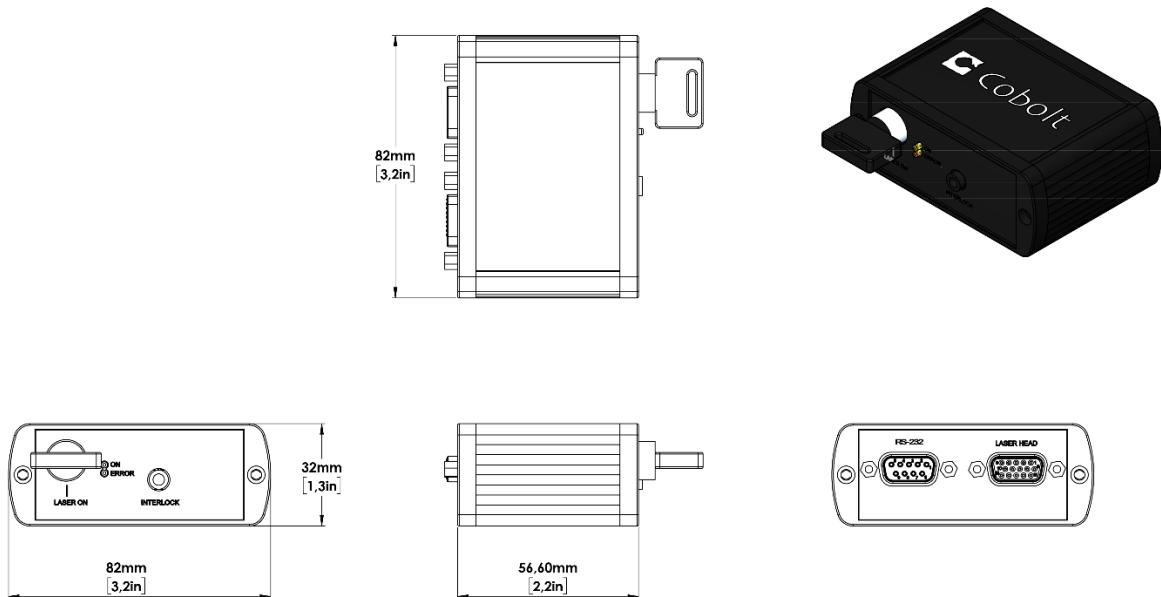

Tor Series Key control box, mechanical outline. Dimensions in mm [inches].

6.3. Remote Interlock Connector

CE / CDRH Configuration

The remote interlock connector on the key switch box is a 3.5 mm female stereo (TRS) audio socket on the key control box. The ring and sleeve (see figure below) must be connected for the laser to operate. To use the remote interlock connector with an external switch, connect a stereo plug instead.

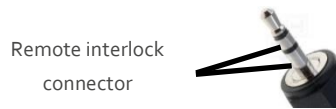

OEM Configuration

The remote interlock connector is located at pin 1 and 2 of the Molex connector on the laser head. The connector can be short-circuited with an interlock jumper (included at delivery) for operation of the laser. To use the remote interlock connector with an external switch, connect a pin 1 and 2 on a Molex plug, see section 6.5. After the remote interlock connector has been opened the laser will need to be reset by disconnecting from and then reconnecting to the power supply in order to start again. Alternatively, it can be re-started using a special sequence of commands, see Section 8.3 for further details. The signal level is between 0 V and +5V with a pull up resistor, and the current required to ground the remote interlock connector is 5 mA. The time delay in the hardware is < 20ms.

6.4. Direct Input control



NOTICE This function is not available for CDRH compliant models and cannot be used with key control box.

The Direct Input control feature enables turning the laser On and Off using a 5 VDC signal. After having configured the laser for Direct Input operation (factory set or by executing @cobasdr 1), the laser can only start-up when 5 VDC (max 12.5 VDC) is applied to pin 12 on the Control I/O Molex connector with 0 VDC on pin 2 as reference, see section 6.5. Shifting the signal to 0 VDC on pin 12 will turn the laser off and put the laser in stand-by mode. This input only controls the on/off state of the laser and cannot be used to modulate the laser output. The remote interlock jumper between pin 1 and 2 must also be placed as described in the section above.

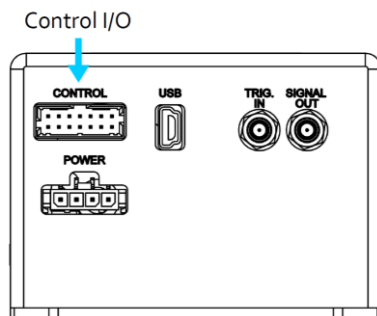

Molex connector on back side of laser head.

6.5. Pin assignment

All equipment connected to the system should be limited energy as described by IEC 61010:1.

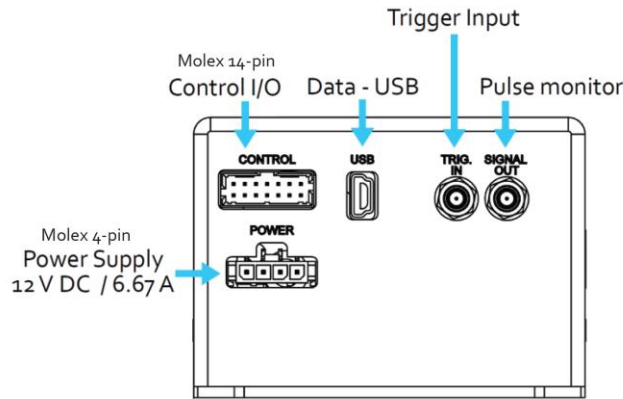

Connectors on the back side of the laser head.

6.5.1. Laser head

Control I/O

The pin configuration for the 14 pin Molex connector on the back side laser head is described in the table below.

Pin	Signal	Signal Detail
1	Remote interlock	3.3 V, Pull up
2	0 V – Ground	
3	--	
4	RS-232 TX	
5	RS-232 RX	
6	LED 1A (LASER ON)	3.3 V, 470 Ω (out)
7	LED 1B (LASER ON)	3.3 V, 470 Ω (out)
8	LED 2 (ERROR)	3.3 V, 470 Ω (out)
9	--	
10	--	
11	Key Switch	
12	Direct Input (+5 V Input)	3.0 – 12 V (In)
13	0 V – Ground	
14	Trigger In (0 - 5 V)	

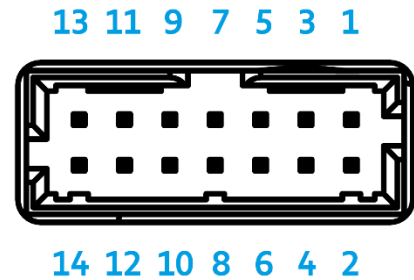

14 pin Molex socket on laser head

Data connector - USB

Connector USB-type, manufacturer Hsuan Mao C8320-05BFDSBo, mates with connector mini-B.

Pin	Function
1	+5 V
2	D-
3	D+
4	Not connected
5	0 V (GND)

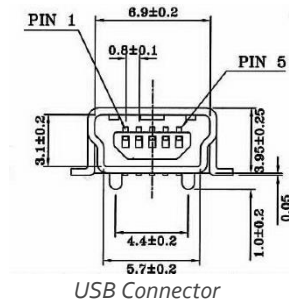

Power supply connector

The pin configuration for the Molex 4-pin connector is described below.

Pin	Function
1	0 V – Ground
2	0 V – Ground
3	+ 12 V - DC
4	+ 12 V - DC

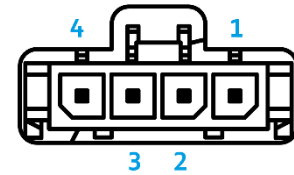

4 pin Molex socket on laser head

6.5.2. Key control box

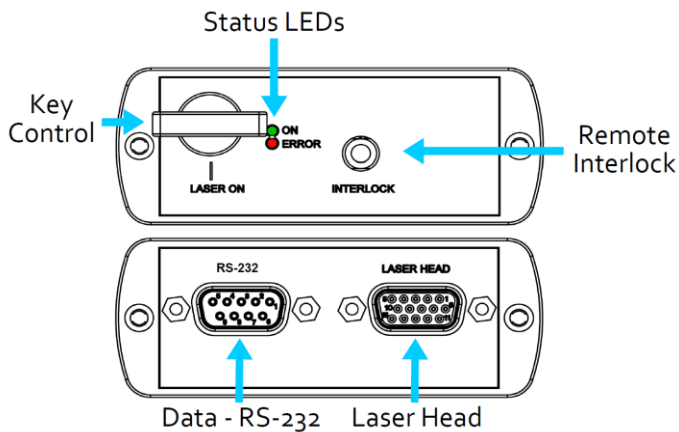

Remote interlock connector



Connection to Laser head

The pin configuration for the 15-pin D-SUB on the key control box are described in the table below.

Pin	Function
1	LED 1A (LASER ON)
2	LED 2 (ERROR)
3	--
4	0 V – Ground
5	Key Switch
6	--
7	RS-232 TX
8	RS-232 RX
9	--
10	0 V – Ground
11	Remote interlock
12	--
13	--
14	--
15	0 V – Ground

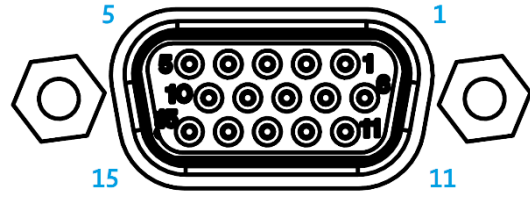

15 pin Sub-D connector on the key control box

Data connector – RS 232

The pin configuration for the 9 pin Sub-D (serial) connector on the key control is described in the table below.

Pin	Function
1	--
2	RS-232 TX
3	RS-232 RX
4	--
5	0 V – Ground
6	--
7	--
8	--
9	--

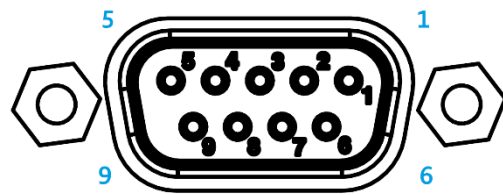

7. Operating Instructions

As standard, all lasers are delivered with the laser set in Auto-start mode. As soon as power is supplied to the laser head the temperature control elements are operating to reach set-point values and the laser emission will start, unless the key-switch is enabled (CDRH model), at 1kHz (factory setting).

7.1. Internal and External Triggering

The Cobolt Tor™ XE is an actively triggered, passively Q-switched laser, meaning that each optical pulse emitted by the laser is triggered, either by the integrated drive electronics, or by an external trigger signal source connected to the SMB connector marked "Trig In" on the backside of the laser or to the 14 pin molex. Consequently, the repetition rate of the laser is controlled by the trigger source used to operate the laser.

The laser can be operated with three different types of trigger source settings: the internal trigger, an external trigger, or a combination of the two, named gated trigger. Switching between the three trigger source settings can be done either in Cobolt Monitor™ or by using the commands listed in Section 8.3. Once the trigger source is changed, the laser will restart to activate the new trigger setting.

Regardless of which trigger source that is being used, the measured pulse repetition rate of the laser is displayed in Cobolt Monitor™ (see figure below). The measured repetition rate can also be acquired by sending the command `rlf?` to the laser.

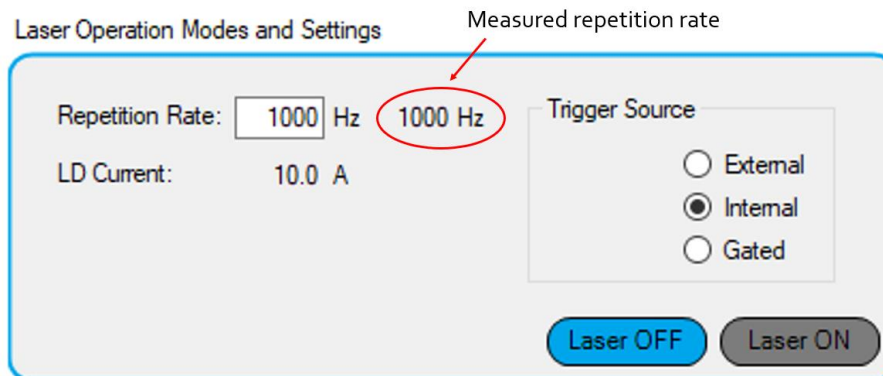

The Cobolt Tor™ XE monitors the pulse repetition rate which is displayed in the Cobolt Monitor™ software.

As standard, all lasers are set to operate with an internal trigger source at 1000 Hz upon delivery. Here follow instructions of how to operate the Cobolt Tor™ XE laser using the various trigger source settings.

7.1.1. Internal trigger

As standard, all lasers are set to operate with the internal trigger source at 1000 Hz upon delivery. This functionality is provided by the integrated drive electronics. The repetition rate of the laser can be changed either using the Cobolt Monitor™ software, or by sending commands to the laser.

In the Cobolt Monitor™ software, the pulse repetition rate can be changed by changing the value in the field named "Repetition Rate".

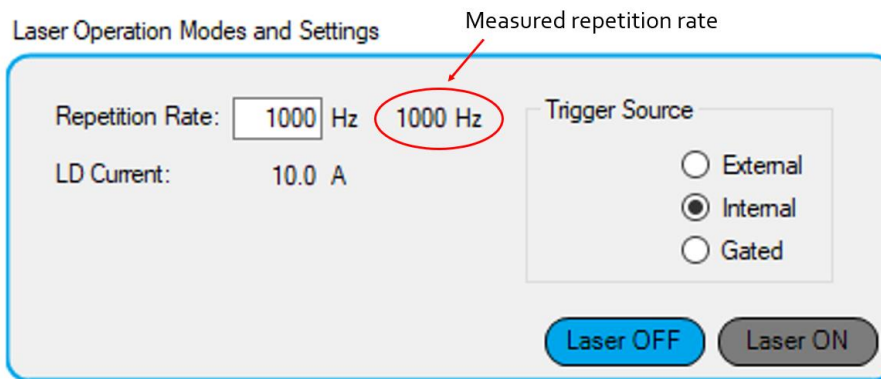

To use the internal trigger functionality, set trigger source to "Internal". To change the repetition rate, change the value in the field.

The repetition rate can also be changed by sending the command `sif XXX` where `XXX` is the repetition rate in Hz. For example, to set the internal trigger source to a repetition rate of 600 Hz, send the command `sif 600`. To read the repetition rate setpoint of the internal trigger source, the command `gjf?` can be used.

To activate the internal trigger source select 'Trigger source internal' in the Cobolt Monitor™ software or by send the command `slt internal` to the laser.

7.1.2. External trigger

The Cobolt Tor™ XE laser can also be operated using an external trigger source, by connecting an external trigger signal to the SMB connector on the backside of the laser marked "Trig In", or to the Molex connector on Pin 14 and Pin 13, see Section 6.5. The laser will be triggered on the **rising edge** of the external signal and emit one optical pulse per triggered event. The external trigger signal should be setup as following (illustrated in the figure below):

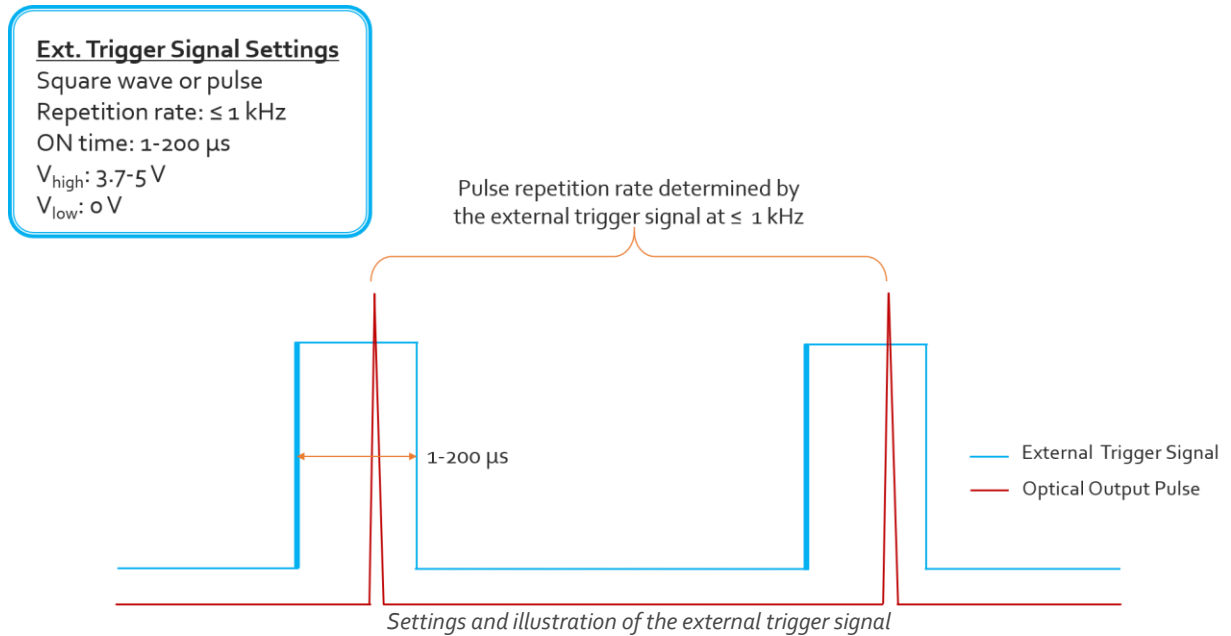

NOTICE The laser will trigger on the rising edge of the external signal and emit one optical pulse per triggered event.

To use the laser with an external trigger source select 'Trigger source: External' in the Cobolt Monitor™ software, or send the command `slt external` to the laser.

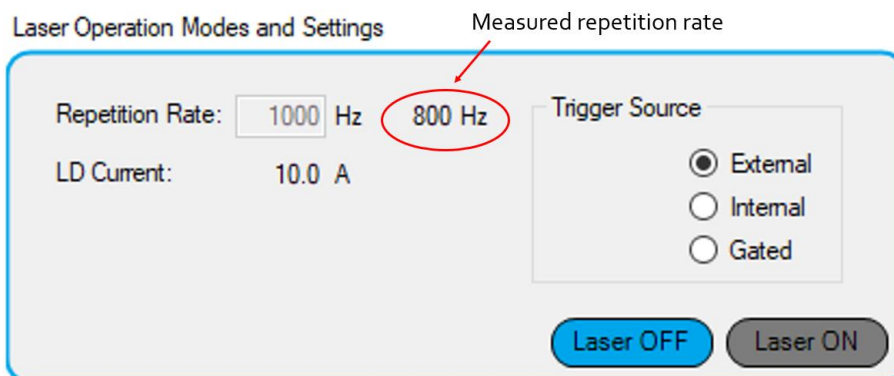

To use the external trigger functionality, set trigger source to "External". The repetition rate of the laser is set by the external signal supplied to the laser. The measured repetition rate of the laser is displayed.

7.1.3. Gated trigger

A third alternative is to run the Cobolt Tor™ XE using the gated trigger setting. This setting is combination of the internal trigger functionality and an external trigger source.

While using the gated trigger setting, the laser will emit optical pulses during the time that an external constant trigger signal with a magnitude above 3.7 V is applied to the SMB connector marked "Trig In", as illustrated in the figure below. The repetition rate of the pulse train is set by the internal trigger functionality.



NOTICE The laser will emit optical pulses while an external constant trigger signal with a magnitude above 3.7 V is applied

To activate the gated trigger functionality, choose the 'Trigger source: Gated' in Cobolt Monitor™ software, or send the command `slt gated` to the laser. The repetition rate of the laser, during the time an external trigger signal is applied, is set by the internal trigger source, and can be changed by entering a value in the field 'Repetition rate' or by sending the command `sif XXX` where `XXX` is the repetition rate in Hz.

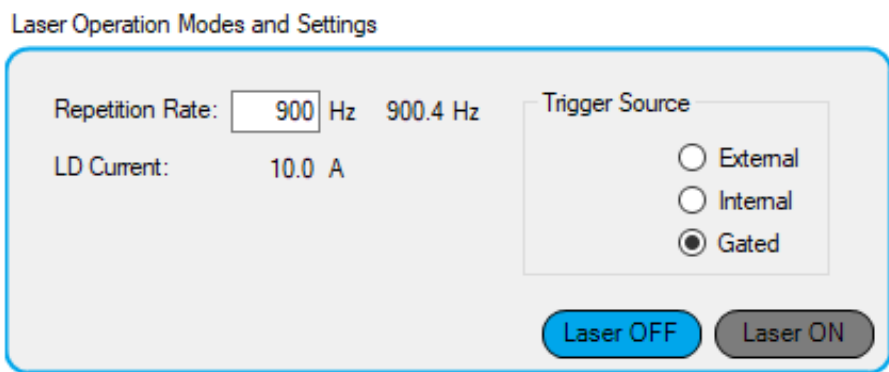

To use the gated trigger functionality, set trigger source to "Gated". To change the repetition rate of the emitted pulse train, change the value in the field

7.2. Pulse Monitor Output

The laser head contains a pulse monitor which delivers a signal through the SMB connector marked "SIGNAL OUT" on the backside of the laser. The output signal is a digital signal, returning a square electric pulse when the optical pulse is detected by the internal pulse monitor. Alternatively, the output signal can be configured as an analog signal upon request, please contact your sales representative for more details.

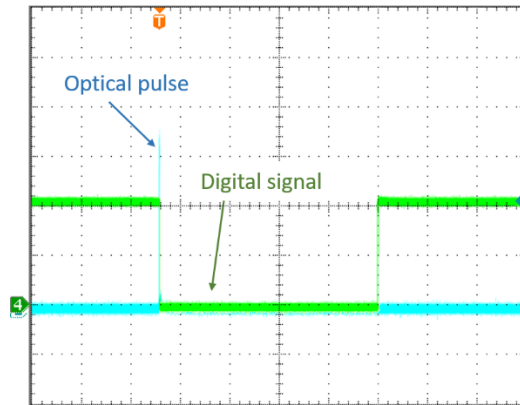

Illustration of the digital signal from the pulse monitor, shown with the optical pulse on in blue and the signal from the pulse monitor in green.

8. Operation via data port

8.1. Handshaking

Under no circumstances does the system initiate communication; it only transmits characters in response to a message. Every message generates a response, either a numerical value or the acknowledgment string "OK". In the event that the system receives a message that it cannot interpret, it responds: "Syntax error:" followed by the complete command string (minus the termination character) that caused the error. Every system response is terminated by a carriage return (ASCII 13) and a full stop is used with floating numbers.

8.2. USB driver

When using Cobolt Monitor™ with Windows 10, the USB device is automatically detected. When using Windows 8 or earlier (e.g Windows 7, Vista, XP) it is necessary to install the Cobolt signed USB driver. To be able to connect to a Cobolt Tor™ XE laser via USB, a USB driver must be installed on the computer. The USB driver can be downloaded from <https://hubner-photonics.com/>. When installed, a virtual COM port will be created to communicate with the laser. To install the USB driver in Windows 7 follow these instructions:

1. Go to the **Control Panel** and choose **Hardware and Sound**.

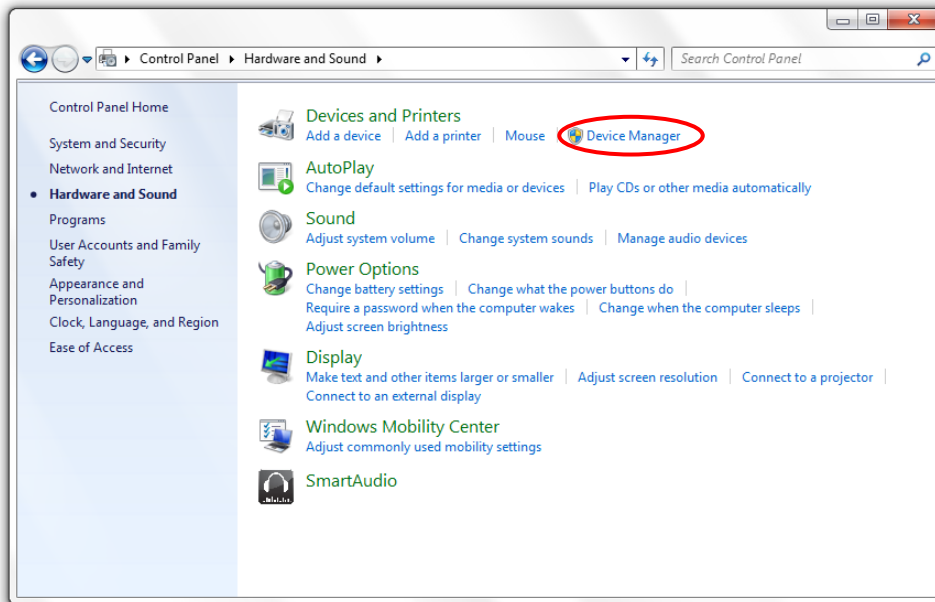

2. Under the **Devices and Printers** section, choose **Device Manager**.
3. Under **Other devices**, find the device called **Cobolt Laser Driver**. Right-click it and chose **Update Driver Software**.

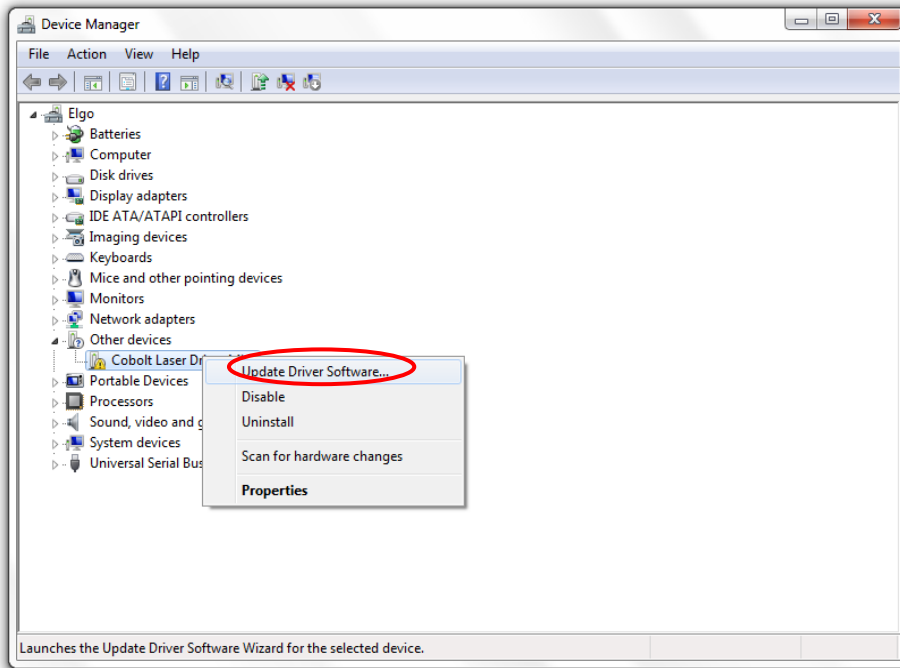

4. On the next screen chose the **Browse my computer for driver software** option.

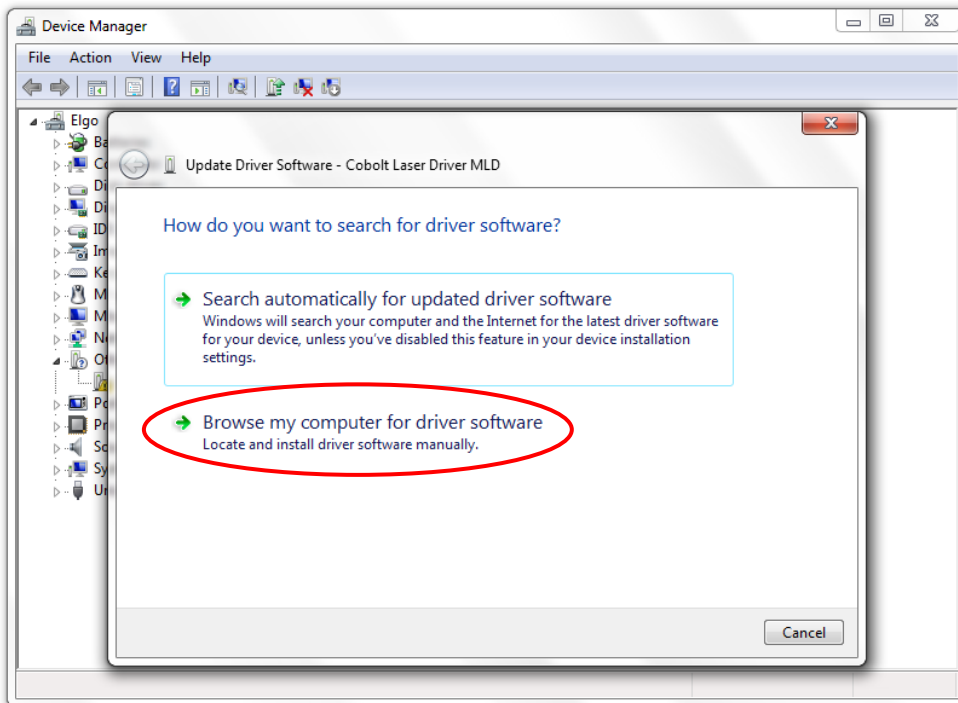

5. Click **browse** and find the folder on your computer where the USB driver is stored.

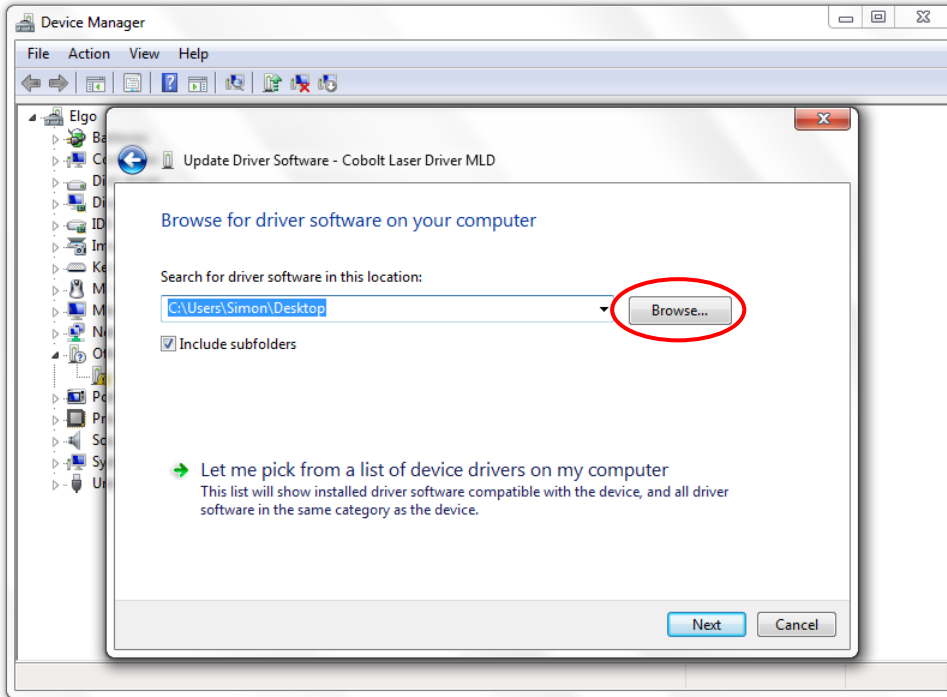

6. Windows security may warn you that the publisher of the driver is unverified. Choose **Install this driver software anyway**.

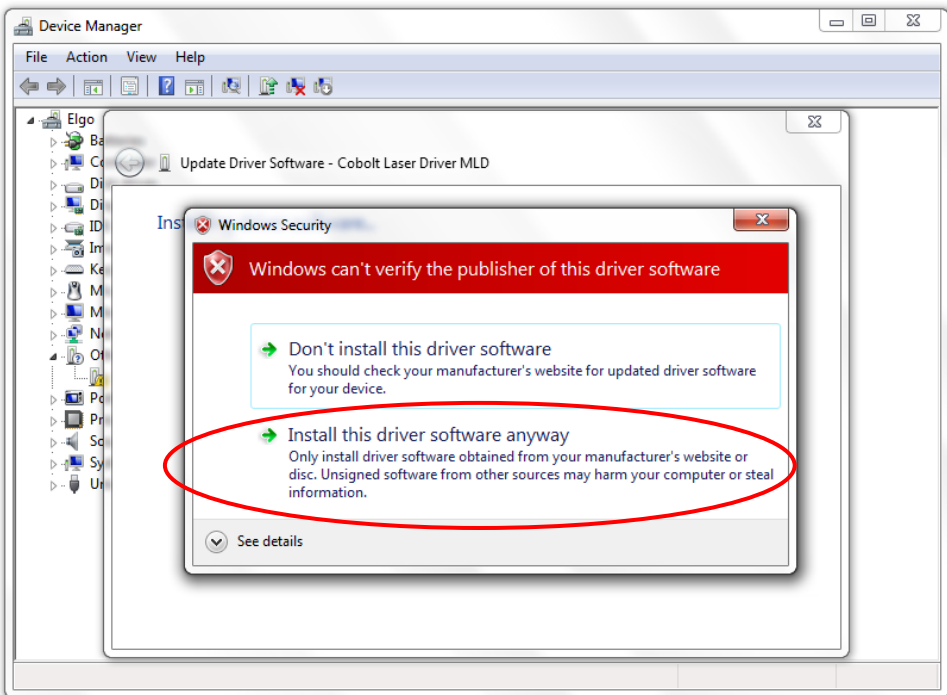

7. The installation should now be complete.

8.3. Communication commands

The laser is delivered with the system set in Auto-start mode (see section 3.1 for Auto-start sequence description). As long as power is supplied to the system the temperature control elements are always operating to reach set-point values and the laser will be idle waiting for a command.

The computer will treat the laser as a serial device and assign it a COM port, and serial communication can be established with the laser using the following configuration:

- Baud rate: 115200
- No parity
- Termination for commands: CR +LF
- Termination for answers: CR
- Byte size: Eight bits
- 1 stop bit

Commands to operate the lasers are listed in the table below. All commands are case sensitive and command **arguments** must be delimited by a single space character (ASCII 32).

Under no circumstances does the system initiate communication; it only transmits a response to each command, either a numerical value, a string or the acknowledgment string "OK". In the event that the system receives a command that it cannot interpret, it responds: "Syntax error: illegal command".

Command	Function	Argument	Returned value
hrs?	Get laser head operating hours		Float
ilk?	Get interlock state		0 = OK, 1 = interlock open
@cobas?	Get autostart enable state		0 = disabled, 1 = enabled
l?	Get laser ON/OFF state		0 = OFF, 1 = ON
@cob1	Laser ON		
lo	Laser OFF		
leds?	Status of 4 LEDs		Int [0:15] Bit 0 = "POWER ON" Bit 1 = "LASER ON" Bit 2 = "LASER LOCK" Bit 3 = "ERROR" 1 = LED on 0 = LED off
f?	Get operating fault		no fault 3002 – pulse repetition rate out of range 5001 – interlock fault 700X – temperature fault
cf	Clear fault		
sn?	Get serial number		32-bit unsigned integer

sif	Set the frequency of the internal trigger signal	Desired repetition rate in Hz	
gif?	Get the set frequency of the internal trigger signal		
rlf?	Read laser repetition rate		Float
slt	Change the trigger setting to internal	internal external gated	
glt?	Get the trigger signal setting		Internal External Gated

For restarting the laser with control commands after having opened the remote interlock switch, execute "cf" for clear fault followed by "@cob1" to restart the laser. On CDRH models the key needs to be toggled to restart the laser.

9. Troubleshooting

In the unlikely case of a problem occurring, use the list below to help identify the error. In case of a sudden voltage drop the laser will turn itself off and restart. If it is in CDRH configuration it will require that the key is turned on again. Some faults can be fixed remotely. Contact your sales representative to identify corrective action.



WARNING - Under no circumstances, do not open the laser head since this will void the warranty of the laser.

No laser emission 5 minutes after start-up

1. Verify that the remote interlock connector is properly connected.
2. Verify the supply voltage is within the range stated in Section 5.5
3. Make sure the mechanical shutter on the laser head is open. **OBS!** Do **NOT** look in to the laser beam.
4. Verify is the laser is working. When the laser is operating correctly, it emits a faint tune in the set pulse repetition rate (1000 Hz). If the faint tune can be heard and no laser emission can be detected, contact your sales representative.
5. If an external trigger source is used, verify that the laser is working correctly by setting the trigger source to "Internal" and 1000 Hz pulse repetition rate while troubleshooting the laser and restart the laser. If laser emission is detected while using the internal trigger functionality, verify that the external trigger source is set according to specifications in Section 7.1.2.
6. Verify that autostart is enabled. Click the restart button in the Monitor software or send the command "@cob1" to force a restart of the laser (OEM only).
7. Ensure the laser has adequate heat management, see Section 5.4.
8. Check the base plate temperature (this is displayed in the Cobolt Monitor™ software). If the baser plate temperature is outside of the range 20-50 °C the laser may either take longer time to stabilize the temperature of the temperature controlling elements or it might be unable to do so.
9. Send the command "f?" to see if the laser reports any error.
 - a. If fault code 7001 is returned, check that the heatsink is adequate, and that the ambient temperature is under 40°C.
 - b. If fault code 5001 is returned, see interlock fault checklist.
 - c. If any other fault code is returned, contact your sales representative.
10. Contact your sales representative if you are unable to resolve the issue.

Interlock fault

1. If using a custom interlock system, connect the supplied remote interlock connector plug to check whether the interlock is correctly wired.
2. This remote interlock connector should be connected as described in section 6.3.
3. In the software, check if "Interlock Fault" is displayed. Send the command "ilk?" to confirm the Remote interlock connector is not open (returns '1' if the interlock is properly connected).
4. If it is verified that the Remote Interlock Connector system is closed yet an interlock fault is returned, contact your sales representative.

Laser emission stops

1. When the laser is operating correctly, it emits a faint tune in the set pulse repetition rate (1000 Hz). If the faint tune can be heard and no laser emission can be detected, contact your sales representative.
2. If an external or gated trigger source is used, first verify that the laser is working correctly by setting the trigger source to "Internal" and 1000 Hz pulse repetition rate while troubleshooting the laser and restart the laser. If laser emission is detected while using the internal trigger functionality, verify that the external trigger source is set according to specifications in Section 7.1.2.
3. Ensure the laser has adequate heat management
4. Check the base plate temperature (this is displayed in the Cobolt Monitor™ software). If the base plate temperature is outside of the range 20-50 °C the laser may either take longer time to stabilize the temperature of the temperature controlling elements or it might be unable to do so
5. Check that the Remote Interlock Connector is connected.
6. Send the command "f?" to see if the laser reports any error.
 - a. If fault code 7001 is returned, check that the heat sink is adequate, and that the ambient temperature is under 40°C.
 - b. If fault code 5001 is returned, see interlock fault checklist.
 - c. If any other fault code is returned, contact your sales representative.
7. Contact your sales representative if you are unable to resolve the issue.

10. Warranty and Maintenance

HÜBNER Photonics issues warranty covering 12 months, with unlimited operation hours. The laser systems are designed for modular repair or replacement in the event that the laser head malfunctions. Warranty is invalid if the laser system is operated outside of the specific limits and conditions as outlined in this document.

The Cobolt lasers are contained in sealed enclosures and should not be opened for any reason. Disassembly of any part of the system (including the cable) means the system no longer complies with the EMC standards and will void the warranty. All laser parameters are set at the factory, and there are no adjustments required. Maintenance is limited to wiping dirt off the enclosures and cleaning the aperture.

11. Service

Due to accuracy tolerances, calibration differences and allowed power drift there may be discrepancies between the manufacturer measurement of the optical output power and the customer measurement equipment. If the output power deviates from the reported value, please contact your local representative for an online re-calibration. If the laser does not function, do not attempt to open any of the units, or the warranty will be voided. Contact your local representative for consultancy and to request an RMA number (see back cover for contact information). If an RMA number is issued and the laser needs to be shipped back to the manufacturer or your local representative, please pack the complete system for shipment using the original package or equivalent. Ensure the unit is free from thermal paste before packing. The warranty covers repair or replacing the unit at the option of the manufacturer.

12. Compliance (CDRH models only)

The CDRH model lasers (-1100) are designed and manufactured to comply with the EC Low Voltage Directive and the EC EMC Directive in the CDRH-compliant configuration of laser head, key control box, key and power supply. All equipment must be mounted on a common ground plane, such as an optical table. If any part of the delivered equipment is replaced with a part not supplied by Cobolt AB, a part of HÜBNER Photonics, or if the equipment is not properly grounded, the system may not conform to CE / CDRH compliance standards listed here. Disabling any of the safety features nullifies the CE marking and violates the laser safety standard.



The following harmonized and limits standards have been applied:

Electrical Safety	EN 61010-1, IEC-61010-1, UL 61010-1 (Limited Energy System) UK S.I. 2016 No. 1101 : The Electrical Equipment (Safety) Regulations 2016
Laser Safety/Class	IEC-60825-1 FDA / CDRH : Complies with 21 CFR 1040.10 and 1040.11 except for conformance with IEC 60825-1 Ed. 3., as described in Laser Notice No. 56, dated May 8, 2019.
EMC	IEC 61326-1 EN 55011 Electromagnetic Emission , Class A Electromagnetic Immunity – Table 1 Requirements EN 61000-4-2 Electrostatic Discharge ±4 kV contact discharge and ±2 kV, ±4 kV, ±8 kV air discharge EN 61000-4-3 Radiated electromagnetic fields 80 – 1000 MHz, 3 V/m with 80 % AM @ 1 kHz 1.4 – 2.7 GHz, 3 V/m with 80 % AM @ 1 kHz EN 61000-4-4 Fast transient / Burst AC Power input port ±2,0 kV EN 61000-4-5 Surge AC Power input port ±0,5 kV, ±1,0 kV, ±2,0 kV Com. Mode AC Power input port, ±0,5 kV, ±1,0 kV Diff. Mode EN 61000-4-6 Conducted Immunity 3 V with 80 % AM @ 1 kHz EN 61000-4-11 Dips and Interruptions 50 Hz and 60 Hz. Test voltages: 100 V and 230 V UK S.I. 2016 No. 1091 : Electromagnetic Compatibility Regulations 2016 FCC 47 CFR - Part 15 (2009): Subpart B, Class A
RoHS	EU Directive 2011/65/EU, EU 2015/863 and amendment EU 2017/2102 UK S.I. 2012 No. 3032

Contact your sales representative for a copy of the full Declaration of Conformity.

13. Disclaimer

HÜBNER Photonics will assume no responsibility for damage incurred by faulty customer equipment, such as measurement equipment, cables etc, used in conjunction with HÜBNER Photonics laser products. HÜBNER Photonics makes no warranty of any kind with regard to the information contained in this manual, included but not limited to, implied warranties of merchantability and suitability for a particular purpose. HÜBNER Photonics shall not be liable for errors contained herein nor for incidental or consequential damages from the furnishing of this information. No part in this manual may be copied, reproduced, recorded, transmitted, or translated without the express written permission by HÜBNER Photonics.



Our Locations

Cobolt AB , a part of HÜBNER Photonics (Sales in Norway, Sweden, Finland and Denmark)

Solna, Sweden
Phone: +46 8 545 912 30
Fax: +46 8 545 912 31
E-mail: info@coboltlasers.com

HÜBNER Photonics GmbH (Sales in Germany, Switzerland and Austria)

Kassel, Germany
Phone: +49 561 994 060 - 0
Fax: +49 561 994 060 - 13
E-mail: photonics@hubner-germany.com

HÜBNER Photonics Inc. (Sales in USA, Canada and Mexico)

San Jose, California, USA
Phone: +1 (408) 708 4351
Fax: +1 (408) 490 2774
E-mail: info.usa@hubner-photonics.com

HÜBNER Photonics UK (Sales in UK and Ireland)

Derby, Great Britain
E-mail: info.uk@hubner-photonics.com

www.hubner-photonics.com

Australia

Warsash Scientific Pty Ltd
www.warsash.com.au

Benelux

Laser 2000 Benelux CV
www.laser2000.nl

Brazil

Photonics Instrumentos
www.photonics.com.br

China

DynaSense Photonics Co. Ltd.
www.dyna-sense.com

Estonia, Latvia and Lithuania

Optek Ltd
www.optek.lv

France

Optoprim
www.optoprim.com

India

Spectral Instrument System
www.spectralinstruments.com

Israel

Lahat Technologies Ltd
www.lahat.co.il

Italy

Crisel Instruments
www.crisel-instruments.com

Japan

Kantum Electronics Co Ltd
www.kantum.co.jp

Pneum Co, Ltd Japan
www.pneum.co.jp

Poland

Amecam
www.amecam.pl

Russia and Belarus

Azimuth Photonics
www.azimp.ru

Russia and Belarus

Azimuth Photonics
www.azimp.ru

South Korea

BM Laser Solutions Co.,Ltd
www.bmlaser.co.kr

SM Tech

www.lasersystem.co.kr

Singapore, Malaysia and Thailand

Wavelength Opto-Electronic
www.wavelength-tech.com

Spain and Portugal

Laser Technology SI
www.laser-technology.com

Taiwan

Tayhwa Technology Co Ltd
www.tayhwa.com.tw

HÜBNER Photonics

