

Cobolt Rogue™ Series

High Power | CW Diode pumped lasers

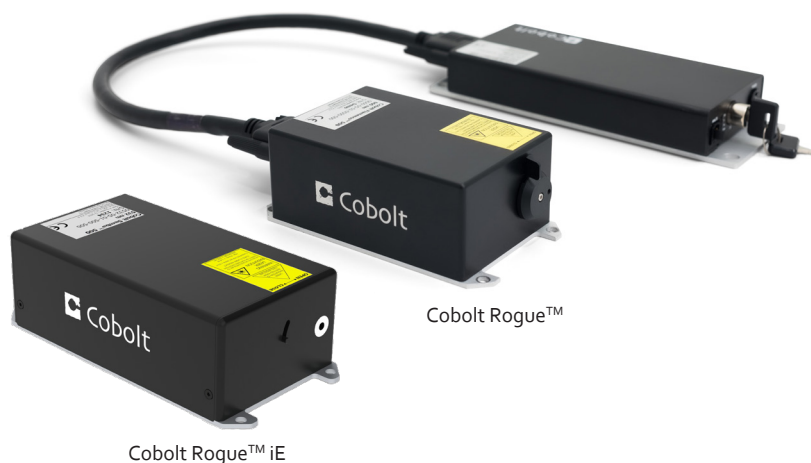

Applications

Widefield fluorescence microscopy
Flow cytometry
Super-resolution microscopy
DNA sequencing
High content analysis

- 640 nm
- CW output power up to 1 W
- Spectral bandwidth < 150 GHz (200 pm)
- Perfect TEM₀₀ beam
- Stable output power < 2 % peak-to-peak over 8 hours
- Ultra-robust, hermetically sealed packages

Cobolt Rogue™ Series lasers are continuous-wave diode pumped lasers (DPL) operating at a fixed wavelength. The lasers are built using proprietary HTCure™ manufacturing technology for ultra-robustness in a compact hermetically sealed package.

As a complement to our Cobolt 05-01 Series of single frequency lasers, the Cobolt Rogue™ Series lasers have higher optical power and a spectral bandwidth of < 150 GHz. The lasers emit a very high quality laser beam with stable characteristics over a wide range of operating conditions, they are designed and manufactured to ensure a high level of reliability.

The Cobolt Rogue™ iE is a fully integrated laser device, including all control electronics. The Cobolt Rogue™ iE eliminates the need for an external controller, bringing the trusted laser performance of Cobolt Rogue™ Series into a compact, self-contained device.

Cobolt Rogue™ Series lasers are intended for stand-alone use in laboratory environments or for integration as OEM components in instruments for applications including fluorescence microscopy, flow cytometry, DNA sequencing and High content analysis.

Typical Beam Profile

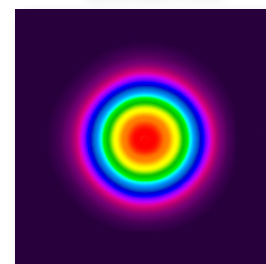

Cobolt Rogue™ 640 nm
M² < 1.1

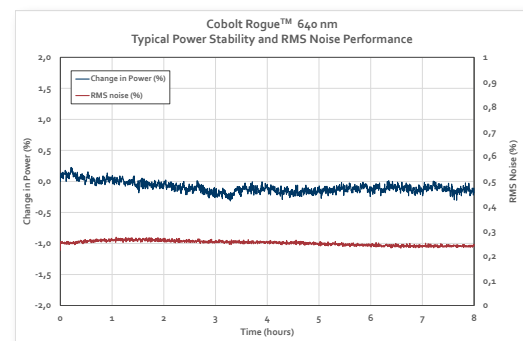

Cobolt Rogue™ Series

Performance Specifications

Center wavelength	639.6 ± 0.3 nm
Available Power Levels	1.0 W
Noise, 20 Hz - 20 MHz (rms)	< 0.5 %
Power stability (8 hrs ± 3°C)	< 2%
Beam divergence (full angle)	< 1.4 mrad
Spatial mode (TEM ₀₀)	M ² < 1.1
Beam diameter at aperture	700 ± 50 μm
Spectral bandwidth (FWHM)	< 150 GHz (200 pm)
Beam symmetry at aperture	> 0.90:1
Beam pointing stability (over 10-40°C)	< 10 μrad/°C
Polarization ratio (linear, vertical)	> 100:1
Warranty	24 months, unlimited hours

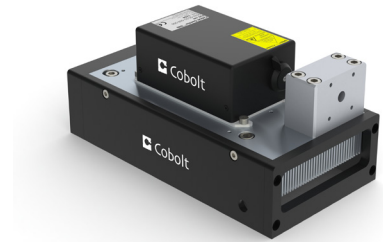

Cobolt Rogue™ Series laser on a heat sink for fiber coupling (FIC-04)

Operational Environment

	Rogue™	Rogue™ iE
Power supply requirements	15 VDC, 6 A	12 VDC, 6.7 A
System power consumption	< 65 W, typical 30W	
Maximum laser head baseplate temperature	45 °C	45 °C
Ambient temperature, operation	10 - 35 °C	10 - 35 °C
Laser head heat sink thermal impedance (at max ambient temperature)	< 0.18 K/W	< 0.15 K/W
Ambient temperature, storage	-10 -> +60 °C	
Humidity	0 - 60 % RH non-condensing	
Ambient air pressure	950 - 1050 mbar	

Model Number

WWWW-05-41-PPPP-CCC

Wavelength ↑ Power ↑ Configuration: ↑

500 = Gen 5b Controller, RS-232, CE / CDRH
 600 = Gen 5b Controller, RS-232, OEM
 700 = Gen 5b Controller, USB, CE / CDRH
 800 = Gen 5b Controller, USB, OEM
 1100 = Integrated electronics, CE / CDRH
 1200 = Integrated electronics, OEM
 xxxx = OEM customization



This device contains components that may be sensitive to Electrostatic Discharge (ESD). ESD protection can be achieved with proper electrical grounding.



Avoid eye or skin exposure to direct or scattered radiation.
 Class 4 Laser Product
 Classified per IEC 60825-1:2014



Wvl (nm) Max.Pwr (mW)
 640 2000

Communication Interface

Communication	USB or RS-232
Standard Baudrate	115200



Cobolt Rogue™ Series

Electrical Interfaces

Cobolt Rogue™ - Laser head

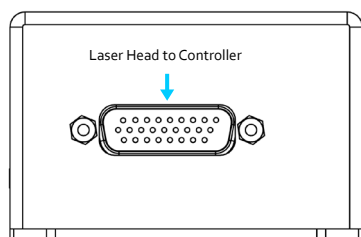

Cobolt Rogue™ - Controller

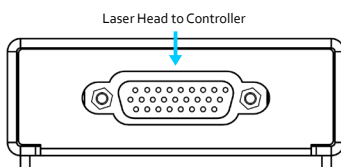
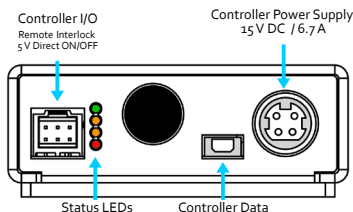

Molex 6 pin - Controller I/O

Pin	Function
1	Remote interlock
2	0V – Ground
3	Direct Input
4	--
5	LED 1 (LASER ON)
6	LED 2 (ERROR)

Cobolt Rogue™ iE - Laser head

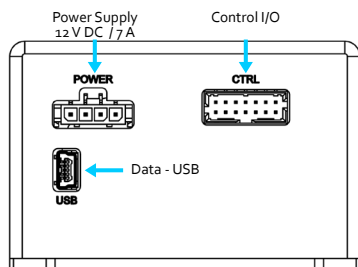

Molex 14 pin - Control I/O

Pin	Function
1	Remote interlock
2	0V – Ground
3	0V – Ground
4	RS-232 TX
5	RS-232 RX
6	LED 1A (LASER ON)
7	LED 1B (LASER ON)
8	LED 2 (ERROR)
9	--
10	--
11	Key Switch
12	Direct Input
13	0V – Ground
14	--

Molex 4 pin - Power Supply

Pin	Function
1	0V – Ground
2	0V – Ground
3	+ 12V - DC
4	+ 12V - DC

Cobolt Rogue™ iE - Key control box

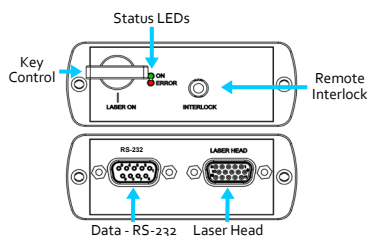

Sub-D 15 pin - Control I/O

Pin	Function
1	LED 1A (LASER ON)
2	LED 2 (ERROR)
3	--
4	0V – Ground
5	Key Switch
6	--
7	RS-232 TX
8	RS-232 RX
9	--
10	0V – Ground
11	Remote interlock
12	--
13	--
14	--
15	0V – Ground

Sub-D pin - RS-232

Pin	Function
1	--
2	RS-232 TX
3	RS-232 RX
4	--
5	0V – Ground
6	--
7	--
8	--
9	--

Cobolt Rogue™ Series

Mechanical Specifications

Cobolt Rogue™ - Laser head

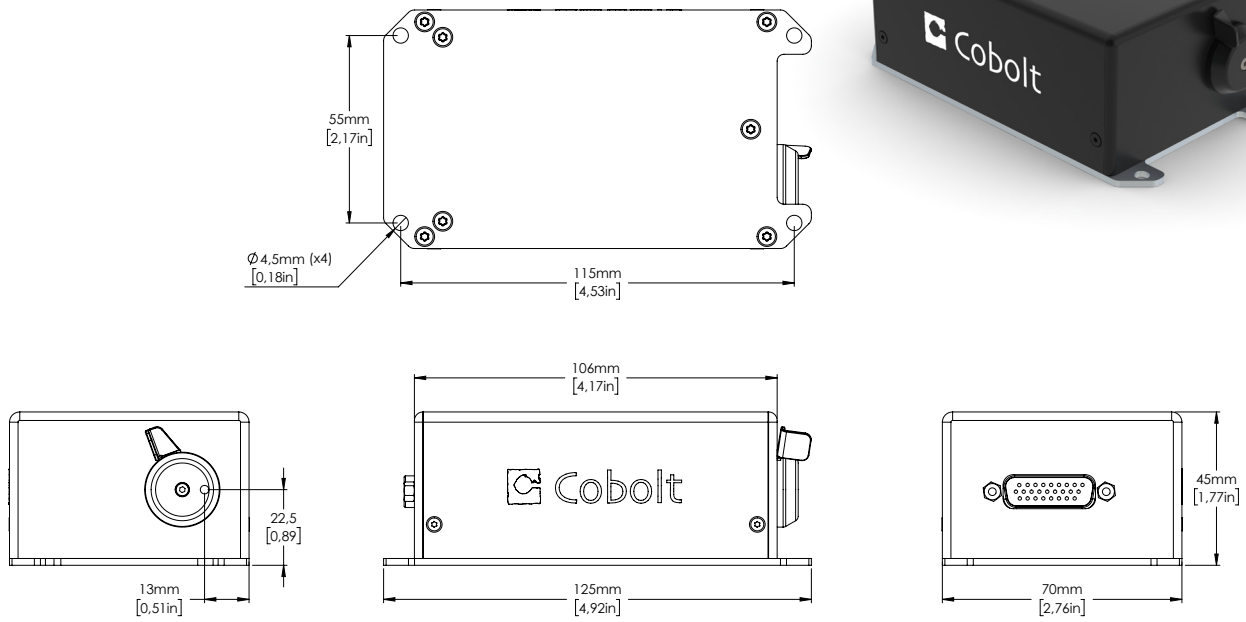

Cobolt Rogue™ - Controller

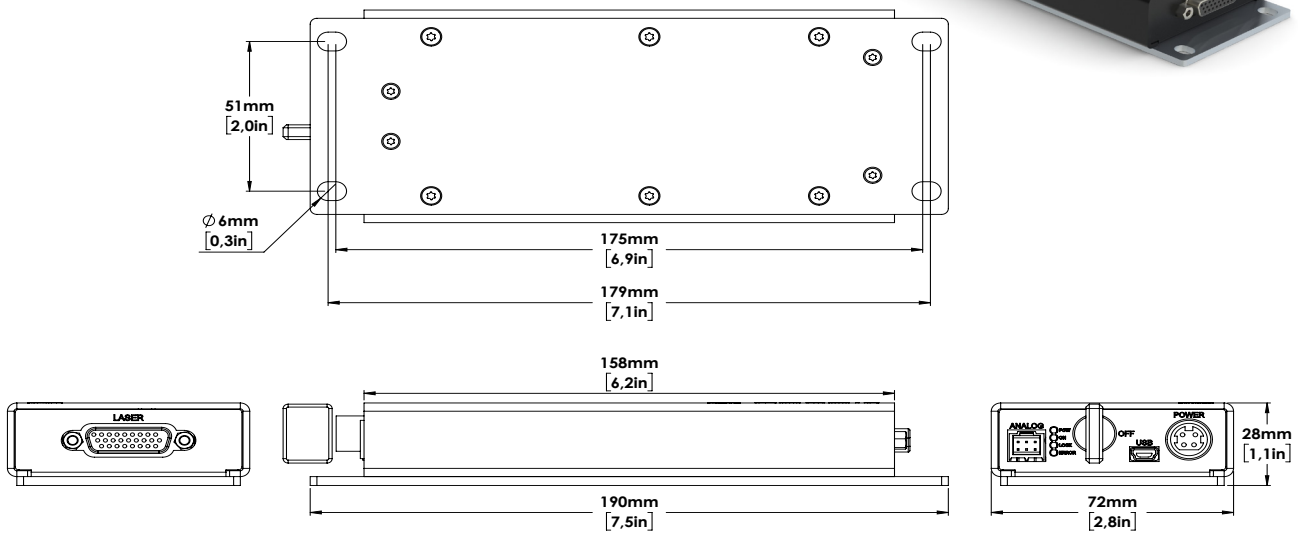

Cobolt Rogue™ Series

Mechanical Specifications

Cobolt Rogue™ iE Laser head

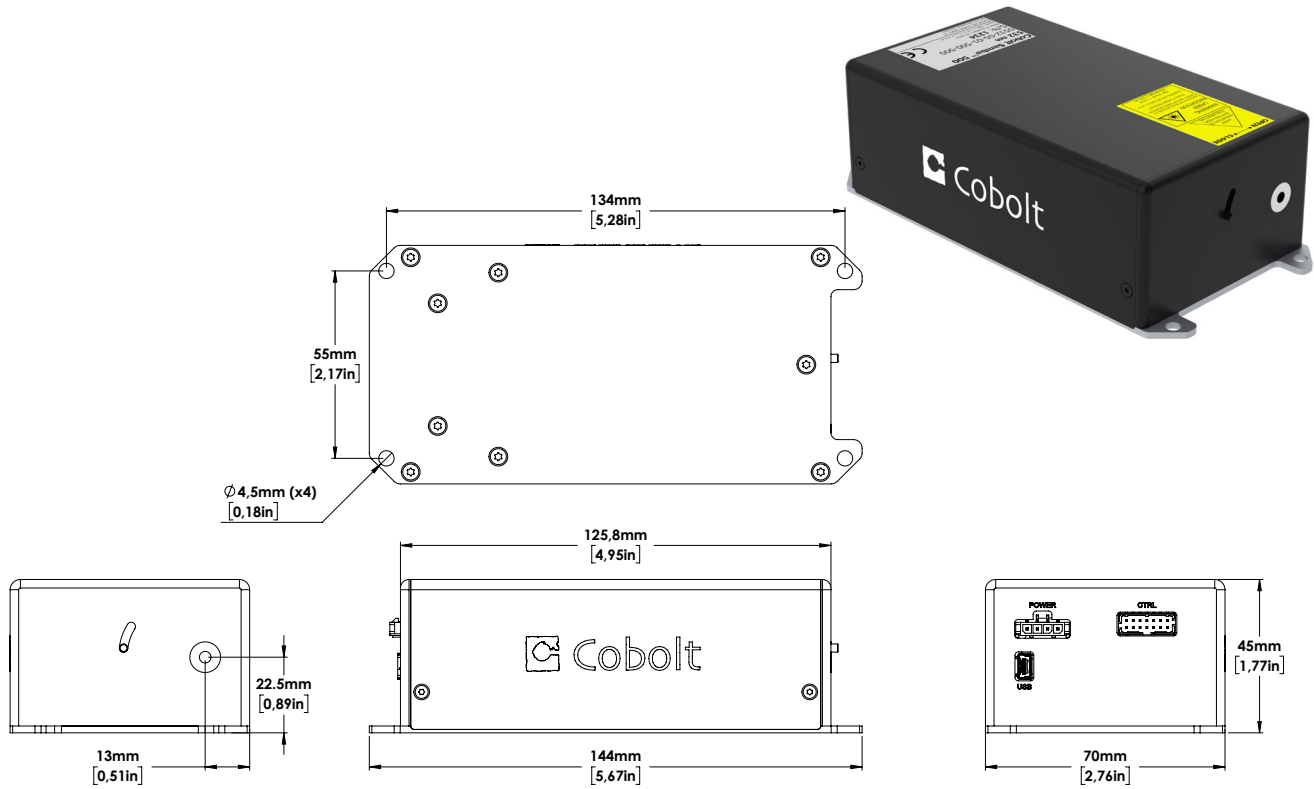

Cobolt Rogue™ iE - Key control box

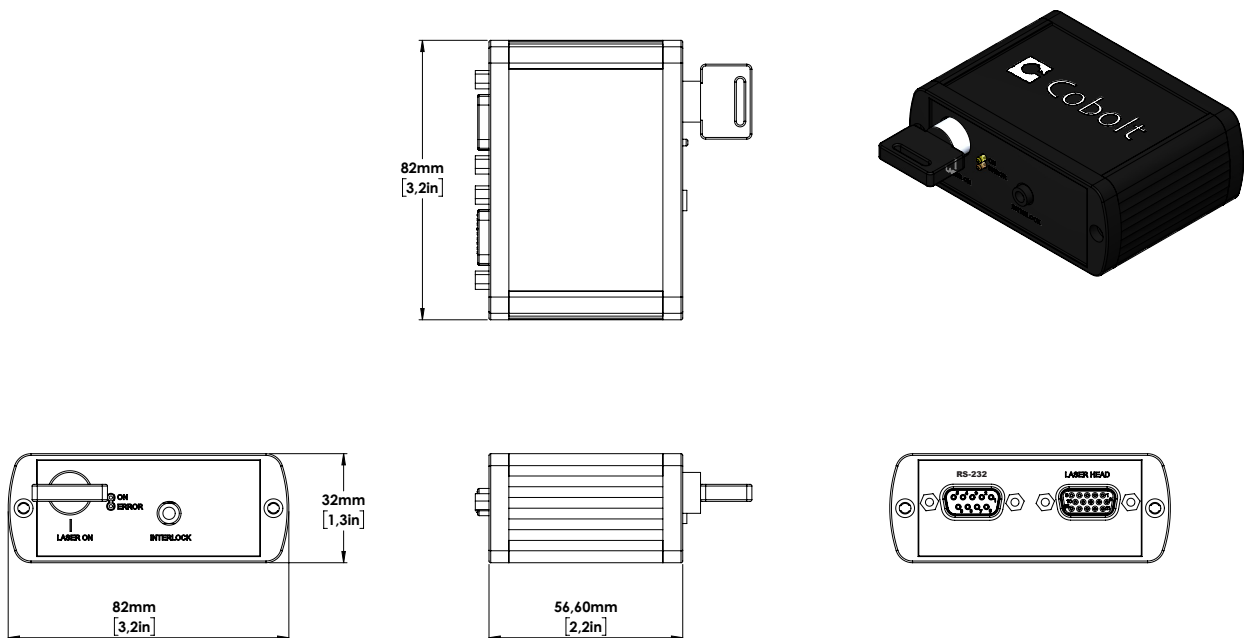

Cobolt Rogue™ Series

Options and Accessories

- C-FLEX Laser combiner
- Laser head heatsink with fans for Cobolt Rogue™ lasers : HS-04
- Laser head heatsink with fans for Cobolt Rogue™ iE lasers : HS-05
- TEC Plate for active baseplate temperature control
- Heatsink with fiber coupling for Cobolt Rogue™ lasers : FIC-04



C-FLEX Laser combiner



Heatsink with fans HS-04

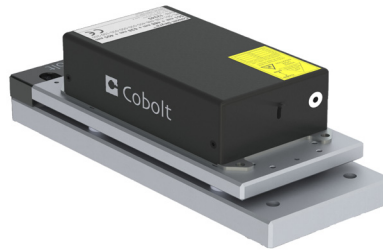

TEC-Plate for active baseplate temperature control

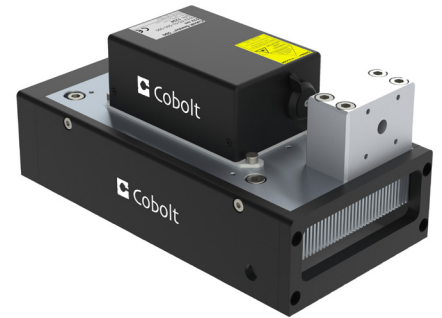

Heat sink with fans for fiber coupling FIC-04

Our Locations

Cobolt AB
(Sales in Norway, Sweden, Finland and Denmark)
Solna, Sweden
Phone: +46 8 545 912 30
Fax: +46 8 545 912 31
E-mail: info@coboltlasers.com

HÜBNER GmbH & Co. KG
(Sales in Germany, Switzerland and Austria)
Kassel, Germany
Phone: +49 6251 770 6686
Fax: +49 6251 860 9917
E-mail: info.de@hubner-photonics.com

HÜBNER Photonics Inc.
(Sales in USA, Canada and Mexico)
San Jose, California, USA
Phone: +1 (408) 708 4351
Fax: +1 (408) 490 2774
E-mail: info.usa@hubner-photonics.com

HÜBNER UK Limited
(Sales in UK & Ireland)
Derby, Great Britain
Phone: +44 2380 438701
E-mail: info.uk@hubner-photonics.com

Find local sales representatives at hubner-photonics.com

Australia, Benelux, Brazil, China, Estonia, Latvia, Lithuania, France, India, Israel, Italy, Japan, Poland, Russia, Belarus, Singapore, Malaysia, Thailand, South Korea, Spain and Portugal, Taiwan

