

Cobolt o6-o1 Series

Plug and play | Modulatable | CW lasers

375 nm	473 nm	561 nm	705 nm	915 nm
395 nm	488 nm	633 nm	730 nm	940 nm
405 nm	505 nm	638 nm	760 nm	975 nm
415 nm	515 nm	647 nm	785 nm	1064 nm
425 nm	520 nm	660 nm	808 nm	
445 nm	532 nm	685 nm	830 nm	
457 nm	553 nm	690 nm	852 nm	



CONTENTS

1.	Introduction	5
2.	Safety	6
2.1.	General	6
2.1.	Symbols in the manual	6
2.2.	Safety features	8
2.3.	Equipment Safety	9
3.	Quick Start Guide	10
3.1.	o6-MLD	10
3.2.	o6-DPL	11
3.3.	o6-MLD Modulation	13
3.4.	o6-DPL Modulation	14
3.5.	Closedown operation	14
4.	Overview	15
4.1.	Model number	15
4.2.	Configuration	16
4.1.	Warning and Identification Labels	17
4.2.	Laser head	19
4.3.	Key control box	19
4.4.	Thermal management	20
4.5.	Power supply requirements	20
5.	System Description	21
5.1.	Optical specifications - free beam lasers	21
5.2.	Optical Specifications Fiber pigtailed lasers (MLD Only)	22
5.3.	Modulation specifications	22
5.4.	Operation and Environmental Specifications	23
5.5.	Electrical interfaces	23
5.6.	Mechanical Interfaces	23
5.7.	Mechanical Drawings	24
5.8.	Remote Interlock Connector	26
5.9.	Direct On/Off control	27
5.10.	Pin assignment	28
6.	Controlling emission in Continuous Wave operation	31
6.1.	RESTART and ABORT Button	31
6.2.	Laser ON and Laser OFF Button	31
6.3.	Optical output power level controls	32
7.	Modulation mode operation	34
7.1.	o6-MLD	35
7.2.	o6-DPL	38
8.	Operation via data port	42
8.1.	Data port connections	42
8.2.	Handshaking	42
8.3.	USB driver	42

8.4.	Communication commands	45
9.	Cobolt Monitor™ Software	48
9.1.	Installation	48
9.2.	Software instructions	48
10.	Troubleshooting	54
11.	Warranty and Maintenance	55
12.	Service	55
13.	Compliance (CDRH models only)	56
14.	Disclaimer	57

1. Introduction

The Cobolt o6-01 Series offers a compact form factor and a wide wavelength span in a plug and play format. The Cobolt o6-01 Series lasers consist of high-performance fixed wavelength laser modules; modulated laser diodes (MLD) and diode pumped lasers (DPL) cover a spectral range between 375 nm and 1064 nm.

The lasers offer optimum beam quality and modulation performance in a compact package, manufactured using Cobolt's unique HTCure™ Technology ensures world-class quality and reliability, as well as unmatched robustness.

Cobolt o6-01 Series lasers add the feature of direct intensity modulation capability, allowing fast and deep modulation from versatile input signals. Cobolt has designed an easy-to-integrate, compact laser with all control electronics fully integrated in a laser head of industry standard size. The Cobolt o6-01 Series lasers are intended for stand-alone use in laboratory environments or integration in analytical instruments for life science including fluorescence microscopy, flow cytometry and DNA sequencing.

Cobolt o6-MLD lasers can be supplied with an ultra-compact and robust fiber delivery option. The fiber is permanently aligned and fixed inside the laser sub-package, using Cobolt HTCure™ Technology, ensuring stable optical output and high polarization extinction ratio (PER > 100:1) over a large temperature range, and insensitivity to transport conditions. The standard configuration is 1 m SM/PM fiber with 3 mm jacketing and FC/APC output connector (non-collimated), but the design is intended for OEM use and type of fiber, connector and lengths can be customized. See section 2 for available wavelength and power combinations.

2. Safety

2.1. General

All Cobolt o6-01 Series lasers are Class IIIB (CDRH), Class 3B (IEC) laser products which emit less than 500 mW of laser radiation within the visible spectrum. The residual emission does not exceed Laser Class 1.

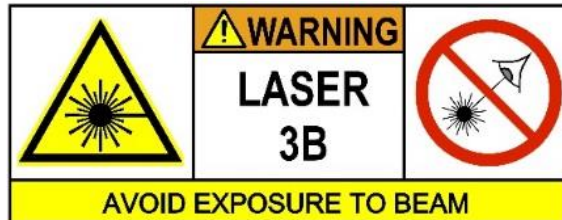

Eye and skin exposure to direct or reflected laser light is hazardous and may be extremely harmful. Always wear eye protection appropriate to the beam wavelength and intensity. Lasers may pose a risk of igniting flammable materials and in event of ignition gasses and fumes may be generated. All equipment used in close proximity to the laser beam should be suitably fire resistant and the facility should be properly ventilated. It is advised to perform a risk assessment for the facility and equipment prior to using the laser. In the case of integration into a larger system, laser safety compliance must be evaluated in the end product. The device must be handled by skilled personnel experienced with lasers, in a laboratory environment and with access to adequate laser safety equipment.

The laser head clearly displays a yellow warning label that shows the location of the laser beam aperture. This label must be visible unless the laser beam is totally enclosed.

2.1. Symbols in the manual



WARNING – LASER RADIATION This symbol is used to call attention to important laser safety information



CAUTION – GENERAL This symbol is used to call attention to important general operator and equipment safety information



NOTICE – GENERAL This symbol is used to call attention to best practices when using the equipment and does not indicate a hazard.

2.1.1. Accessible Emission

The table below describes the irradiance in W/cm² and appropriate level of eye protection in terms of optical density (OD) for each product line.



CAUTION Always wear the appropriate eye protection for all of the specified emitted wavelengths. Verify the accessible emission wavelengths and power levels on the warning label before operating.

Product	Nominal Power (mW)	Nominal Irradiance (W/cm ²)*	Eye protection Requirement**
Cobolt o6-MLD 375	70	27	5
Cobolt o6-MLD 395	120	47	5
Cobolt o6-MLD 405	150	58	4
	365	142	5
Cobolt o6-MLD 415	120	47	4
Cobolt o6-MLD 425	120	47	4
Cobolt o6-MLD 445	100	39	4
	400	156	5
Cobolt o6-MLD 457	100	39	4
	400	156	4
Cobolt o6-MLD 473	100	39	4
	300	117	4
Cobolt o6-MLD 488	60	23	3
	200	97	4
	250	97	4
Cobolt o6-MLD 505	80	31	3
Cobolt o6-MLD 515	80	31	3
	150	58	3
Cobolt o6-MLD 520	80	31	4
Cobolt o6-DPL 532	400	141	4
Cobolt o6-DPL 553	50	18	4
Cobolt o6-DPL 561	200	71	3
Cobolt o6-MLD 633	80	31	3
Cobolt o6-MLD 638	180	70	3
Cobolt o6-MLD 647	130	51	3
Cobolt o6-MLD 660	100	39	3
Cobolt o6-MLD 685	40	16	3
Cobolt o6-MLD 690	200	78	3
Cobolt o6-MLD 730	50	19	3
Cobolt o6-MLD 760	25	10	3
Cobolt o6-MLD 785	250	97	3
Cobolt o6-MLD 808	120	47	3
Cobolt o6-MLD 830	250	97	3

Product	Nominal Power (mW)	Nominal Irradiance (W/cm²)*	Eye protection Requirement**
Cobolt o6-MLD 852	50	19	3
Cobolt o6-MLD 915	250	97	3
Cobolt o6-MLD 940	250	97	3
Cobolt o6-MLD 975	250	97	3
Cobolt o6-MLD 1064	200	78	3

* Irradiance (W/cm²) = 110% of Nominal Power (W) ÷ Beam Area at bottom tolerance (cm²)

** Eye protection (OD) = Log₁₀(Max Power (W) ÷ 60825-1 Emission Limit : Class 1 (W)), rounded up to the next integer.



CAUTION Use of controls or adjustments or performance of any procedures other than those specified herein may result in exposure to hazardous radiation.

2.1.2. Fiber Pigtailed Option

All safety recommendations in section 2.1 are also valid for the Cobolt o6-o1 series fiber pigtailed laser heads. Additionally, heat generated from absorption of laser radiation by particles on the fiber end may increase the probability of ignition hazards in certain environments. Always clean the fiber end before turning on the laser. In systems where the beam is exposed, fiber end must be mounted < 2 m from the emission warning LED on the key control box. It is advised to perform a risk assessment for the facility and equipment prior to using the laser. In the case of integration into a larger system, laser safety compliance must be evaluated in the end product.

2.2. Safety features

The laser is equipped with all required safety features as described in the laser safety standard IEC 60825-1. If any part of the delivered equipment is replaced with a part not supplied by Cobolt or if the equipment is not properly grounded system may not conform to CE / CDRH compliance standards listed in section 0. Disabling any of the safety features nullifies the CE marking and violates the laser safety standard. If the laser does not function, do not attempt to open any of the units, or the warranty will be voided.

Remote Interlock Connector

The remote interlock connector is a connector which permits the connection of external controls placed apart from other components of the laser product. When the terminals of the connector are open-circuited, emission is interrupted, and no radiation will be accessible. The remote interlock connector permits easy addition of an external interlock in laser installation. See section 5.8 for a detailed description of the remote interlock circuit and operation.

Manual Shutter (Beam Stop)

The laser head is equipped with a manual shutter, which functions as the beam stop, capable of preventing human access to laser radiation. The aperture location and the open and close positions of the shutter are indicated on the top surface of the laser head. For o6-o3 fiber pigtailed lasers, the fiber end cap is considered the manual shutter.

Key Control

The CDRH compliant model comes with a key control box which must be connected for the laser to operate. When the key is in the OFF position, the diode is prevented from emitting. The key must be actively turned to the ON position each time the laser is powered on. When the key is removed from the system laser radiation is not accessible.

Laser Radiation Emission Warning

The key control box, which is part of the CDRH compliant models, incorporates LEDs which indicate the status of the Laser. The "ON" LED is illuminated whenever the device is emitting or could emit light. See section 4.3 for details on the key control box. The emission warning indicators are also visible in the Cobolt Monitor™ software, see section 6 for details on the control software.

2.3. Equipment Safety

2.3.1. Back Reflection Sensitivity

Laser light reflected directly back into the laser head causes damage to the laser diode and results in a dramatic decrease in product lifetime. o6-MLD lasers with a wavelength greater than 600 nm are particularly sensitive, exercise extreme caution.

2.3.2. Electrostatic discharge

Always install the laser system to a properly grounded power outlet. Cobolt lasers contain a laser diode which is sensitive to electrostatic discharge (ESD).

2.3.3. Fiber care

It is important to always make sure the fiber end-face is clean before turning the laser on and before connecting the fiber connector in physical contact with another connector. Failure to do so may lead to irreparable damage of the fiber end-face. Do not clean the fiber when the laser is on. We recommend using appropriate equipment for fiber cleaning and inspection.

3. Quick Start Guide

3.1. o6-MLD

1. Mount the laser on a heat sink or suitable flat surface that provides adequate heat dissipation and connection to ground. Use the four holes on the laser's base plate to secure it.

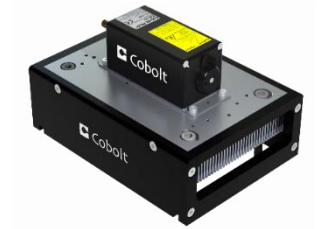

2. Attach the 15-pin D-SUB cable to the laser head.



3. Attach the 15-pin D-SUB cable to the Control Box.



4. Insert the interlock plug into the connector on the laser head.



5. Connect the supplied 5V power supply unit to the socket on the laser head and plug it in to the mains.



6. To start the laser, turn the key on the Control Box clockwise to the ON position. If it is already in the ON position, turn it to OFF and then ON again. Light will be emitted as soon as the key is turned.



- The laser will now start up in continuous-wave, constant current mode at its nominal maximum power level. The power and wavelength may continue to drift for up to 3 minutes while the temperature of the platform stabilizes.



NOTICE If the power does not match the power as stated on the test sheet see Section 12: Service for more information.

3.2. o6-DPL

When delivered the lasers are, by default, set to continuous-wave, constant power mode. As soon as power is supplied to the laser head the auto-start procedure will begin. Light will be emitted once the remote interlock connector is connected, the shutter is open and when the key is turned to the ON position (CDRH model).

- Mount the laser on a heat sink or suitable flat surface that provides adequate heat dissipation and connection to ground. Use the four holes on the laser's base plate to secure it.



- Attach the 6-pin Molex cable to the laser head. Be sure the orange arrow is facing the top (labelled) side of the laser head.



- Attach the 15-pin D-SUB end of the cable to the key control box.



- Insert the remote interlock plug into the connector on the key control box.

- Connect the supplied 5 V power supply unit to the socket on the laser head and plug it in to the mains.



- To start the laser, turn the key on the control box clockwise to the ON position. If it is already in the ON position, turn it to OFF and then ON again.



7. The laser now goes through the following auto-start sequence:
 - Temperature stabilization (1-2 min).
 - Turn the key switch to start the laser. Status LEDs: ON goes on. (CDRH model only)
 - The laser light is emitted in a constant warm-up current for 60 sec.
8. The laser will now start up in continuous-wave, constant power mode at its nominal maximum power level. The power and wavelength may continue to drift for up to 3 minutes while the thermoelectric cooler (TEC) stabilizes.



NOTICE If the power does not match the power as stated on the test sheet see Section 12: Service for more information.

3.3. o6-MLD Modulation

There are three ways of modulating the o6-MLD (digital, analog, and on/off modulation), the simplest of which is the on/off modulation feature, which requires no data connection to the laser. For a detailed guide to operating the laser in modulation modes see section 6 : Modulation mode operation.

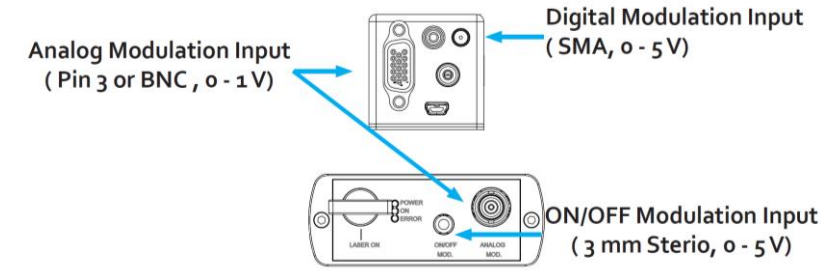

o6-MLD modulation input signal connections

Digital modulation input signal

- Input signal: 0 – 5 V TTL signal, square wave
 - 0.0 – 1.5 V: OFF
 - 3.5 – 5.0 V: ON
- Modulation Frequency: DC – 150 MHz
- Impedance: 1 kΩ

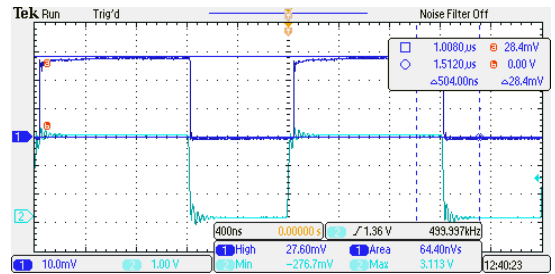

500 kHz digital modulation

Analog modulation input signal

- Input signal: 0 – 1.0 ± 0.3 V, arbitrary waveform
- Modulation Frequency: DC – 2 MHz
- Impedance: 50 Ω or 1.8 kΩ

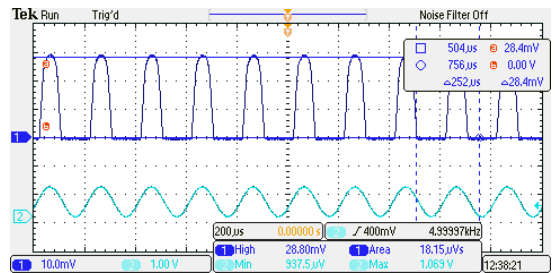

5 kHz analog modulation

ON / OFF modulation input signal

- Input signal: 0 – 5 V TTL signal, square wave
- Modulation Frequency: DC – 500 kHz
- Impedance: High

3.4. o6-DPL Modulation

The o6-DPL can be modulated with digital modulation, analog modulation or a combination of the two. The simplest of which is the digital modulation. For a detailed guide to operating the laser in modulation modes see section 6 : Modulation mode operation.

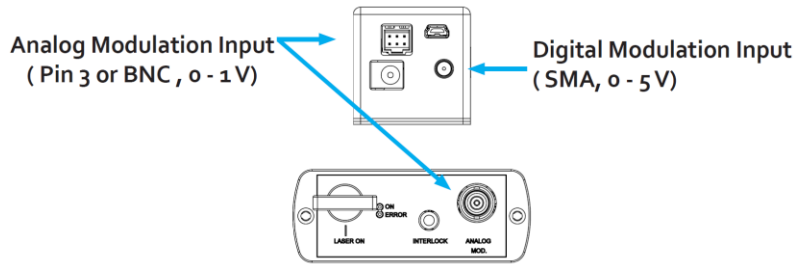

o6-DPL modulation input signal connections

Digital modulation input signal

- Input signal : 0 – 5 V TTL signal, square wave
 - 0.0 – 1.5 V : OFF
 - 3.5 – 5.0 V : ON
- Modulation Frequency: DC – up to 50 kHz (wavelength dependent)
- Impedance: 11 kΩ

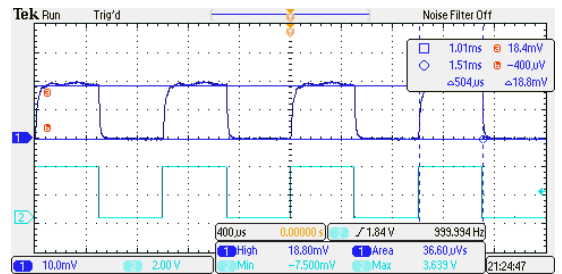

1 kHz digital modulation

Analog modulation input signal

- Input signal: 0 – 1.0 ± 0.3 V , arbitrary waveform
- Modulation Frequency: DC – up to 50 kHz
- Impedance: 1 kΩ

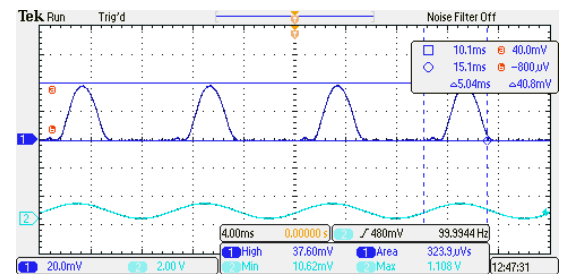

100 Hz analog modulation

3.5. Closedown operation

1. Turn the key switch to OFF first (CDRH models only).
2. Disconnect PSU from mains outlet.
3. Disconnect laser from PSU.
4. Disconnect laser head from Key control box (only required for shipping).

4. Overview

Cobolt o6-o1 Series laser systems consist of four main parts: the laser head, key control box, cable between laser head and key control box, and the power supply (not shown). Always install the laser system to a properly grounded power outlet.



Cobolt o6-MLD with CDRH compliant key control box

4.1. Model number

Cobolt o6-o1 Series lasers are sold in two configurations; CE/CDRH compliant and OEM, described in section o.

The model numbers are composed as described below:

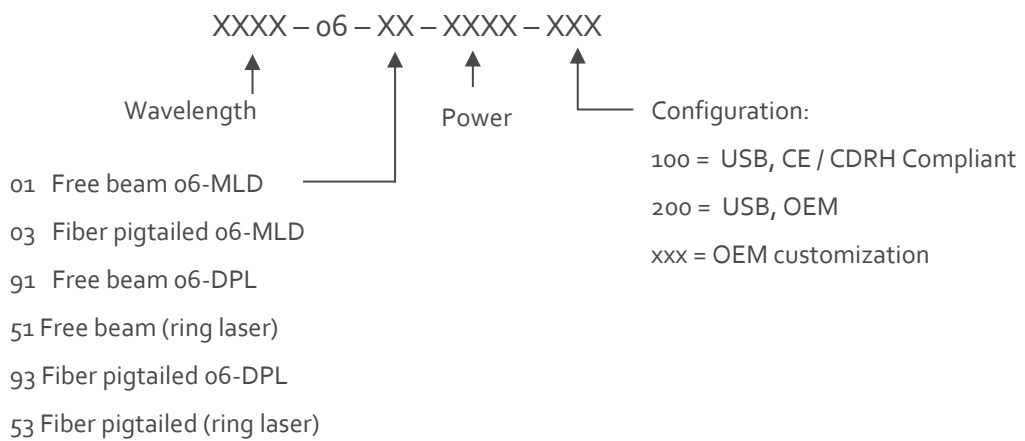

4.2. Configuration

4.2.1. CE/CDRH Compliant

The CE/CDRH compliant system is supplied with a key control box, which must be connected, along with a remote interlock connector. Once power is supplied, laser emission starts when the key is turned from the OFF position to the ON position. The status of operation can be monitored via LEDs on the key control box. Setting the key to its OFF position puts the laser in stand-by mode.

The standard CDRH model consists of:

- Laser head
- Key control box
- Keys
- 5 V power supply unit
- Remote interlock plug (for short circuiting the remote interlock connector)
- USB communication cable
- (o6-MLD) 15-pin D-SUB male-male cable between the laser head and key control box
- (o6-DPL) 6 pin Molex to 15-pin D-SUB cable between laser head and key control box

4.2.2. OEM

The laser head is supplied **without** the key control box. Connecting a 5 VDC power supply to the laser head initiates an automatic start-up sequence. If the remote interlock is connected, laser emission will start automatically as soon as power is supplied, and internal temperatures are stabilized.

The OEM model consists of:

- Laser head
- 5 V power supply unit
- USB communication cable
- Remote interlock plug (for short circuiting the remote interlock connector)

4.1. Warning and Identification Labels

The upper face of the laser head contains a yellow label with laser safety warning and classification information, the wavelength and maximum power of the unit. It also shows the location of the laser beam aperture and indicates the open and closed positions of the manual shutter. This label must be visible unless the laser beam is totally enclosed. A silver label showing information about the laser model, manufacturer date and location, and the power supply voltage and current, is located on the laser head.

4.1.1. Free beam laser head

Manufacturer Identification Labels



OEM label

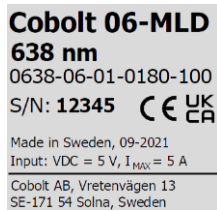

CE /CDRH compliant label

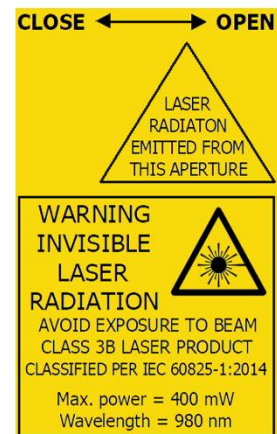

Aperture Warning Labels



Complies with 21 CFR 1040.10 and 1040.11 except for conformance with IEC 60825-1 Ed. 3, as described in Laser Notice No. 56, dated May 8, 2019.

Laser Notice No. 56 Label
 CDRH models shipped to USA

4.1.2. Fiber pigtailed laser head

Manufacturer Identification Labels

Cobolt 06-MLD
405 nm
 0405-06-03-0150-200
 S/N: 12345 **OEM LASER DEVICE**
 Made in Sweden, 09-2021
 Input: VDC = 5 V, I_{MAX} = 5 A
 Cobolt AB, Vretenvägen 13
 SE-171 54 Solna, Sweden

OEM Label

Cobolt 06-MLD
405 nm
 0405-06-03-0150-100
 S/N: 12345 **CE UK CA**
 Made in Sweden, 09-2021
 Input: VDC = 5 V, I_{MAX} = 5 A
 Cobolt AB, Vretenvägen 13
 SE-171 54 Solna, Sweden

CE / CDRH compliant label



Aperture Warning Labels

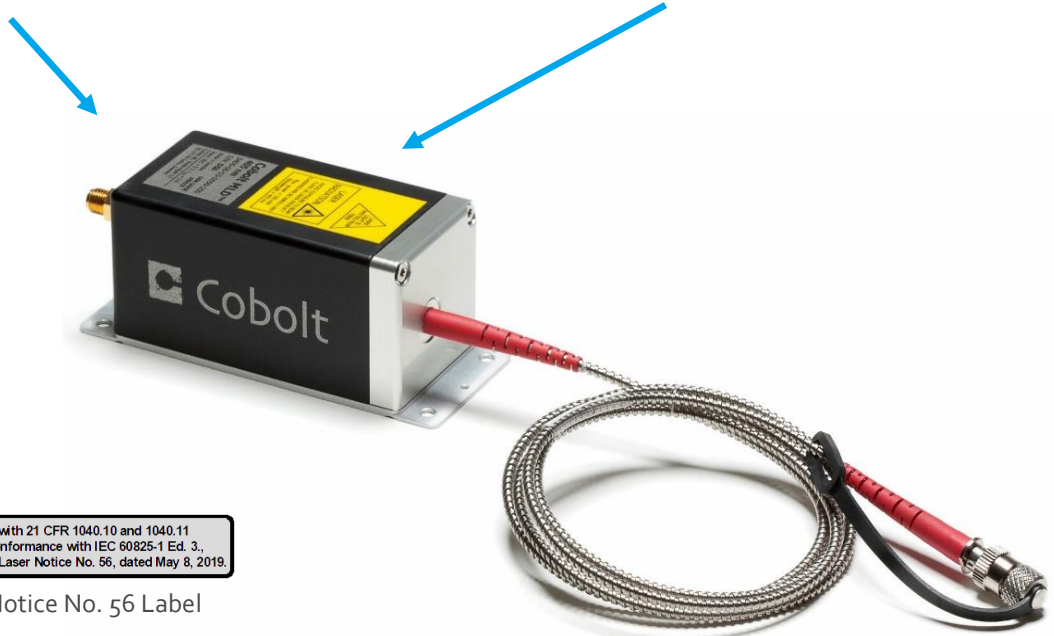

Complies with 21 CFR 1040.10 and 1040.11
 except for conformance with IEC 60825-1 Ed. 3.,
 as described in Laser Notice No. 56, dated May 8, 2019.

Laser Notice No. 56 Label

CDRH models shipped to USA

4.2. Laser head

The laser head contains the laser cavity, beam shaping optics, thermoelectric coolers (TEC) for temperature control and, in o6-DPLs, an optical feed-back loop which ensures long-term power stability of the emitted laser beam. The laser head also features a manual mechanical shutter, a laser hazard label and a laser classification label. When power is supplied to the laser head, regardless of direct on/off or key-switch state, the temperature control element will be active to reach its set point values.

o6-o1 Free beam o6-MLD

Cobolt model o6-o1 are o6-MLD free beam lasers. See section 5.1 for available wavelengths and power levels. The laser head can take electrical power from either the power jack or the 15-pin D-SUB connector. The D-SUB (OEM model only) and the mini-USB can each be used to communicate with the laser. In addition, the laser head features an SMA connector for the digital modulation input and a 2.5mm socket for the interlock.

o6-g1 and o6-51 Free beam o6-DPL

Cobolt model o6-g1 and o6-51 are o6-DPL free beam lasers. See section 5.1 for available wavelengths and power levels. The mini-USB is used to communicate with the laser. In addition, the laser head supplies a Molex 6-pin connection, of which the pin 1 and pin 2 are used for the remote interlock function.

o6-X3 Fiber pigtailed

Cobolt version o6-X3 lasers are o6-o1 Series delivered with a permanently aligned fiber pigtail. The fiber is equipped with a removable output ferrule cover for protection of the fiber end. The fiber output ferrule cover serves as the mechanical shutter of the laser system. See section 0 for available wavelengths and power levels.

4.3. Key control box

The optional key control box allows the user to operate the laser with a CE/CDRH compliant key-switch. It also provides direct connections for analog modulation and (o6-MLD) on/off modulation. The key control Box has LEDs to indicate the laser status. When power is supplied to the laser head, regardless of direct on/off or key-switch state, the temperature control elements will be active to reach set point values.



o6-MLD

The status of the laser operation is given via LED indicators o6-MLD:

- POWER** Green Power is supplied.
- ON** Orange Laser emission is on. This light is on in modulation mode if laser emission is possible.
- ERROR** Red An error has occurred.

o6-DPL

The status of the laser operation is given via LED indicators o6-DPL:

- ON** Orange Laser emission is on. This light is on in modulation mode if laser emission is possible.
- ERROR** Red An error has occurred.

4.4. Thermal management

To ensure operation within given specifications and for the warranty to be valid, the laser head must be mounted on a suitable heat sink. The requirement on thermal resistance of the heat sink can be calculated by taking the difference between the maximum allowed laser head base plate temperature (50 °C) and the ambient temperature at the air-heat sink interface (e.g. 40 °C), divided by the maximum power dissipated from the laser; 12 W for o6-MLD and 20 W for o6-DPL. The o6-MLD laser head must be attached to a heat sink providing a thermal resistance of < 0.8 K/W at 40°C ambient temperature and the o6-DPL requires a heat sink with a thermal resistance of < 0.5 K/W. The mounting surface should be flat within 0.05 mm over mounting surface. Under normal circumstances thermal heat compound is not required, however if the laser is operated in an area with a high ambient temperature it is recommended to use a thermally conductive compound between the laser head and the heat sink to provide good thermal contact. For assistance in thermal management and system integration, please contact your sales representative, see section 12.

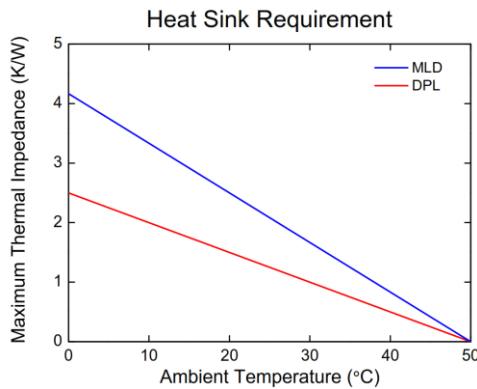

Heat Sink Requirements for Cobolt o6-o1 Series.

4.5. Power supply requirements

An appropriate Power Supply Unit (PSU) is supplied by Cobolt with the laser and can be plugged into a standard power outlet. The power supply accepts 90-264 VAC and 47-63 Hz. Ripple and noise 1.6 % peak-peak max. Accepted voltage range for the laser head is (5.0 ± 0.4) VDC. Specification values are given at 5 VDC. The maximum current is 5 A (max 25 W), though for o6-MLD lasers 3 A is sufficient.

5. System Description

The information presented here is believed to be accurate and is subject to change without notice. The specifications contained herein cannot be guaranteed outside of normal operational conditions.

5.1. Optical specifications - free beam lasers

Center wavelength ¹ (nm)	375 ± 5	395 ± 5	405 ± 5	415 ± 5	425 ± 5	445 ± 5	457 ± 5	473 ± 5	488 ± 3	505 ± 5	515 ± 5	520 ± 5
Product type	o6-MLD											
Output power ² (mW)	70	120	150 365	120	120	100 400	100 400	100 300	60 100 150 200 250	80	80 150	80
Beam divergence, full angle (mrad)	< 1.1		< 1.2					< 1.3				
Spectral bandwidth (FWHM)	< 1.2								< 1.5			
Spatial mode (TEM ₀₀)	M ² < 1.2											
Beam symmetry	> 0.90:1											
Beam diameter at aperture (µm)	700 ± 100											
Polarization extinction ratio	> 100:1											
Noise 250 Hz - 2 MHz (% rms)	< 0.2 %											
Power stability over 8 hrs (%)	< 1 %											
Warranty	12 mo., 5000 hrs						24 months, unlimited hours					

Center wavelength ¹ (nm)	532.1 ± 0.3	552.8 ± 0.3	561.2 ± 0.3	633 ± 5	638 ± 5	647 ± 5	660 ± 5	685 ± 5	690 ± 5	705 ± 10	
Product type	o6-DPL			o6-MLD							
Output power ² (mW)	25 50 100 200 400	25 50	25 50 100 200	80	180	130	100	40	200	30	
Beam divergence, full angle (mrad)	< 1.2			< 1.6				< 1.75		< 1.9	
Spectral bandwidth (FWHM)	< 1 MHz			< 1.2 nm							
Spatial mode (TEM ₀₀)	M ² < 1.1			M ² < 1.2							
Beam symmetry	> 0.95:1			> 0.90:1							
Beam diameter at aperture (µm)	700 ± 70			700 ± 100							
Polarization extinction ratio	> 100:1										
Noise 250 Hz - 2 MHz (% rms)	< 0.3 %	< 0.25 %		< 0.2 %				< 0.5 %	< 0.2 %		
Power stability over 8 hrs (%)	< 2 %			< 1 %				< 2 %			
Warranty	24 months, unlimited hours				24 months or 5000 hours						

Center wavelength ¹ (nm)	730 ± 5	760 ± 15	785 ± 5	808 ± 5	830 ± 5	852 ± 5	915 ± 10	940 ± 5	975 ± 5	1064 ± 10
Product type	o6-MLD									
Output power ² (mW)	50	25	250	120	250	50	250	250	250	200
Beam divergence, full angle (mrad)	< 1.9		< 2.0	< 2.6	< 2.3			< 2.6		< 3.0
Spectral bandwidth (FWHM)	< 2 nm									
Spatial mode (TEM ₀₀)	M ² < 1.2				M ² < 1.3					
Beam symmetry	> 0.90:1									
Beam diameter at aperture (µm)	700 ± 100									
Polarization extinction ratio	> 100:1									
Noise 250 Hz - 2 MHz (% rms)	< 0.2 %									
Power stability over 8 hrs. (%)	< 2 %									
Warranty	24 months or 5000 hours									

1. The wavelength is fixed with this accuracy. The wavelength is specified in air.
2. Power in continuous wave operation mode.

5.2. Optical Specifications - fiber pigtailed lasers

Center Wavelength (nm)	375	395	405	415	425	445	457	473	488	505	515	520	532	553	561	633	638
Product type	o6-MLD												o6-DPL		o6-MLD		
Power (mW)	25	25	75 150	60	60	50 150	50 150	50 150	30 100*	40	40 75	40	25 50 100 200*	25	25 50 100	40	80
Power stability over 8 hrs	< 2 %																
Noise 250 Hz - 2 MHz (% rms)	< 0.3 %																
Exit ferrule	End-cap (red boot)									No end-cap (green boot)							
Fiber Output	FC/APC, non-collimated																
Fiber Type	SM/PM																
Polarization	PER > 100:1, vertical ± 2°																
Standard fiber length	1 m																
Jacketing	1 (m) / Ø 3mm stainless steel jacket																
Warranty	Laser warranty including 12 months on fiber and workmanship																

Center Wavelength (nm)	647	660	685	690	705	730	760	785	808	830	852	915	940	975	1064
Product type	o6-MLD														
Power (mW)	60	50	20	75	15	20	15	100	50	100	20	100	75	50	75
Power stability over 8 hrs	< 2 %														
Noise 250 Hz - 2 MHz (% rms)	< 0.3 %														
Exit ferrule	No end-cap (green boot)														
Fiber Output	FC/APC, non-collimated														
Fiber Type	SM/PM														
Polarization	PER > 100:1, vertical ± 2°														
Standard fiber length	1 m														
Jacketing	1 (m) / Ø 3mm stainless steel jacket														
Warranty	Laser warranty including 12 months on fiber and workmanship														

* With end cap in standard configuration.

5.3. Modulation specifications

	o6-MLD	532 nm o6-DPL	553 nm o6-DPL	561 nm o6-DPL
Digital Modulation				
Bandwidth	DC – 150 MHz	DC – 50 kHz	DC – 5 kHz	DC – 10 kHz
Extinction ratio @10 MHz	> 70 dB	< 6 μs		
Rise/fall time	< 2.5 ns		---	
Input signal	0-5 V, TTL			
Analog Modulation				
Bandwidth	DC-2 MHz	DC – 50 kHz	DC – 5 kHz	DC – 10 kHz
Extinction ratio @250 kHz	> 70 dB		---	
Rise/fall time	< 300 ns	< 6 μs	< 60 μs	< 30 μs
Input signal	0 - 1 V, Arbitrary			
ON-OFF Modulation				
Bandwidth	DC-500 kHz		---	
Extinction ratio	inf:1		---	
Rise/fall time	< 300 ns		---	
Input signal	0-5 V, TTL		---	

5.4. Operation and Environmental Specifications

	MLD	DPL
Power supply requirements	5 VDC, 3 A	5 VDC, 5 A
Intended use environment	Laboratory (indoor)	
Maximum baseplate temperature	50 °C	
Ambient temperature, operation	10 - 40°C	
Ambient temperature, storage	-10 °C to +60°C	
Humidity	0-90 % RH non-condensing	
Ambient Air pressure	950-1050 mbar	
Laser Head heat sink thermal impedance at 40 °C ambient	< 0.8 K/W	< 0.5 K/W
Maximum heat dissipation of Laser Head	< 12 W	< 20 W
Warm-up time from complete "off"	< 3 min	
Communication protocol	USB and RS 232	USB
Ambient temperature & pointing - 20-50 °C	< 5 µrad / °C	
Beam position accuracy (mm)	< 0.5	
Beam angle accuracy (mrad)	< 5	

5.5. Electrical interfaces

All equipment connected to the system should be limited energy as described by IEC 61010:1.

Interface	Location	MLD	DPL
Input power	Laser Head	DC plug 2.5 mm / 5.5 mm female	
Remote interlock connector	Laser Head	2.5 mm audio female	OEM: Molex pin 1 & 2
Data port	Laser Head	USB-type mini B	
Key control Box connector	Laser Head	VGA D-SUB 15-pin male	Molex 6-pin male
Digital modulation	Laser Head	SMA female	
Analog modulation	Laser Head	OEM: D-SUB 15 pin 3 & 4	OEM: Molex pin 2 & 3
Laser Head connector	Key control box	VGA D-SUB 15-pin male	
Remote Interlock connector	Key control box	----	CDRH: 3.5 mm audio female
RS-232	Key control box	D-SUB 9-pin male	---
On/off modulation	Key control box	3.5 mm audio female	---
Analog modulation	Key control box	BNC female	

5.6. Mechanical Interfaces

	MLD	DPL
Laser Head dimensions	100 x 40 x 40 mm	
Fixation holes, Laser head	∅ = 4 x 4.2 mm; 90 mm x 30 mm	
Weight	< 0.2 kg	< 0.3 kg

5.7. Mechanical Drawings

5.7.1. Laser Head

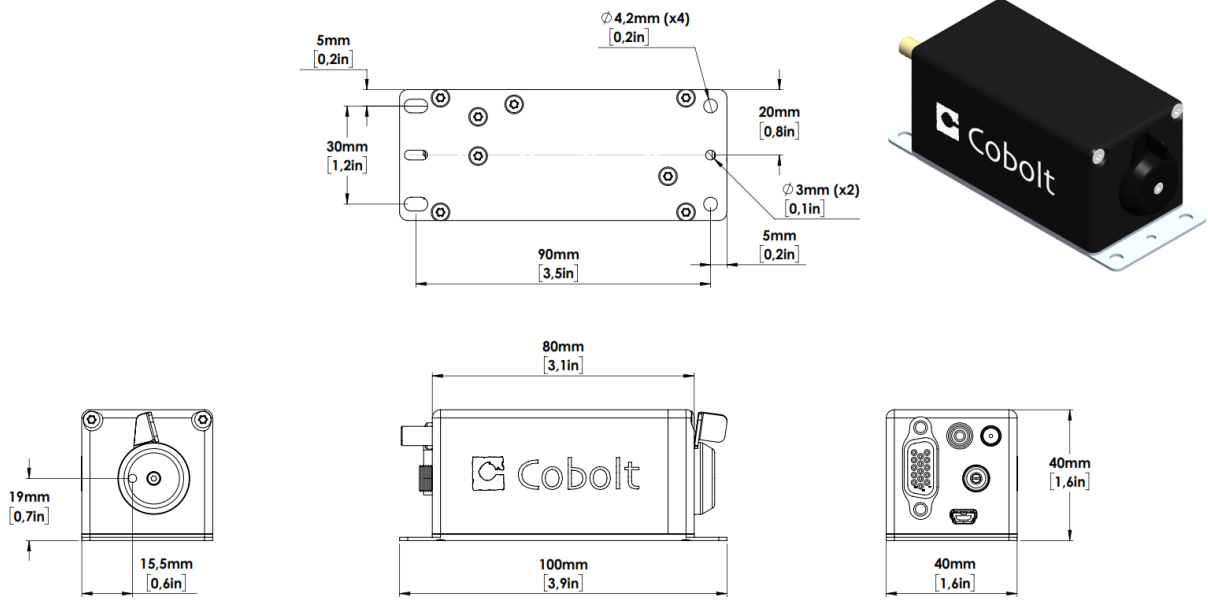

o6-MLD mechanical outline. Dimensions in mm [inches].

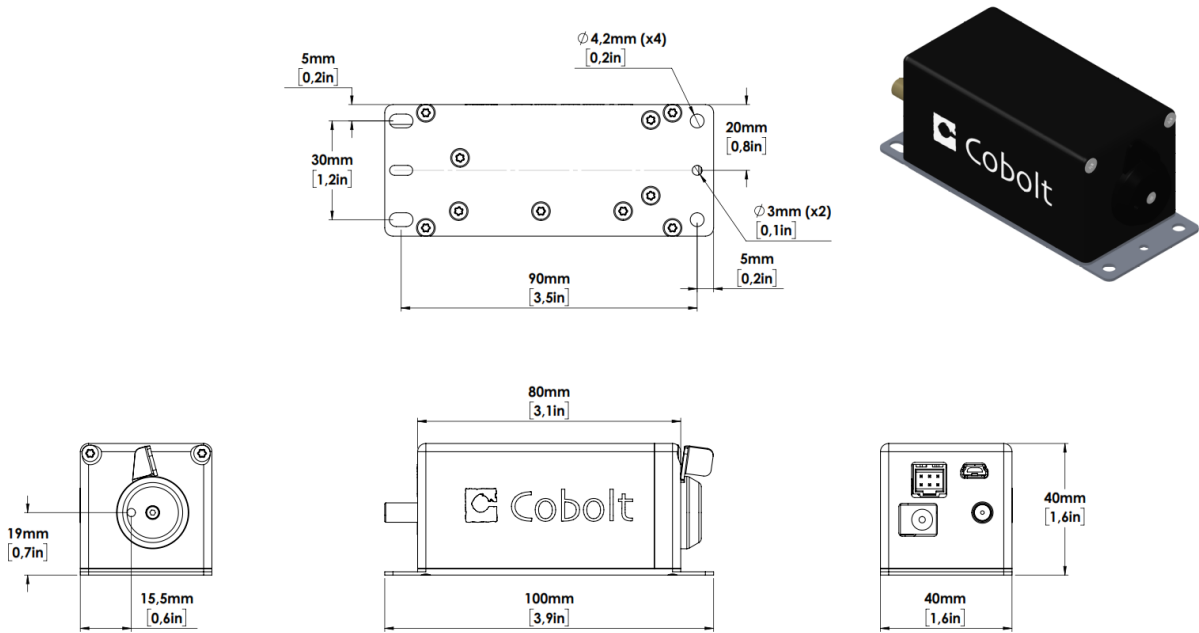

o6-DPL mechanical outline. Dimensions in mm [inches].

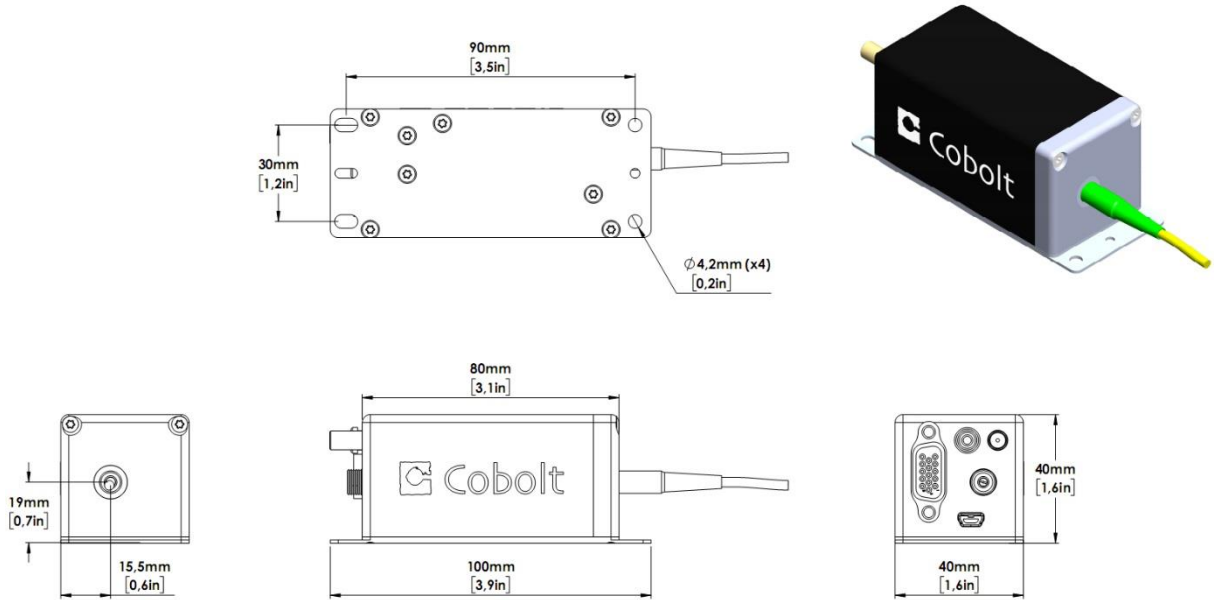

Fiber Pigtailed Laser head mechanical outline. Dimensions in mm [inches].

5.7.2. Key control box

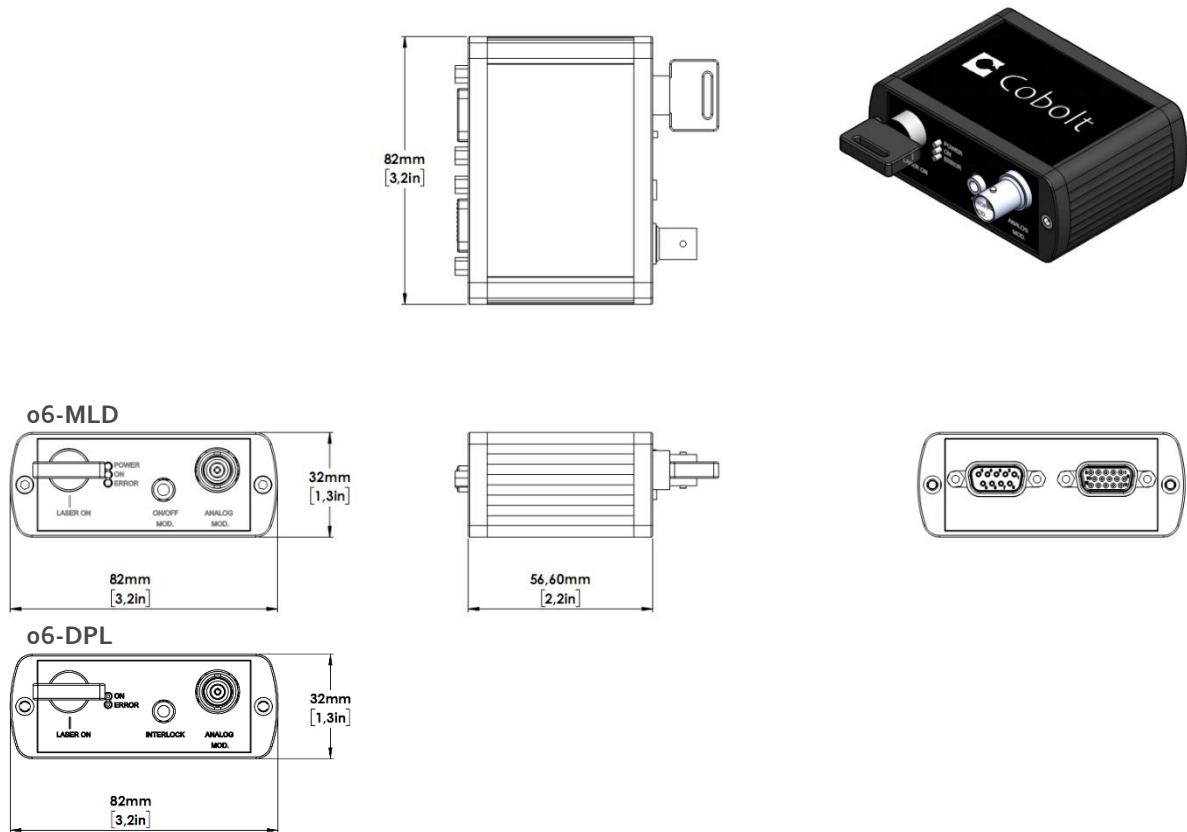

o6-o1 Series Key control box, mechanical outline. Dimensions in mm [inches].

5.8. Remote Interlock Connector

The laser is equipped with a remote interlock connector that prevents current flow through the diode when the circuit is open. After the remote interlock connector has been opened the laser will need to be reset by disconnecting from and then reconnecting to the power supply in order to start again or toggling the key switch. Alternatively, it can be re-started using the 'clear fault' and 'laser on' commands, see Section 8.4 for further details. The signal level is between 0V and +5V with a pull up resistor, and the current required to ground the remote interlock connector is 5 mA. The time delay in the hardware is <math><1\text{ms}</math>, but after filtering by the firmware the reaction time is extended to <math><20\text{ms}</math>.

5.8.1. o6-MLD

The remote interlock connector is a 2.5 mm female stereo (TRS) audio socket. The ring and sleeve (see figure) must be connected for the laser to operate. To use the remote interlock connector with an external switch, connect a stereo plug instead.

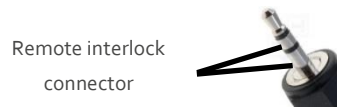

5.8.2. o6-DPL

In OEM configuration the remote interlock connector is located at pin 1 and 2 of the Molex connector on the back side of the laser head. To close the remote interlock connector with an external switch, connect to pin 1 and 2 of the Molex plug.

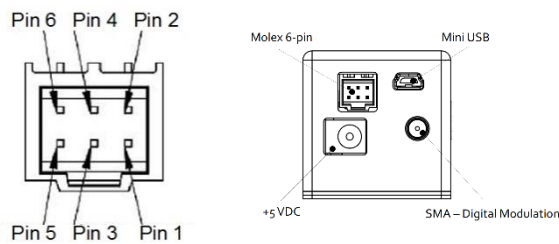

Molex connector on back side of laser head.

In CDRH configuration the remote interlock connector is located on the key control box and a 3.5 mm mono plug is provided to short the circuit. To use the remote interlock connector with an external switch a 3.5 mm stereo plug is required. The ring and sleeve (see figure) must be connected for the laser to operate.

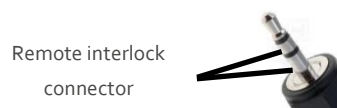

5.9. Direct On/Off control

5.9.1. o6-MLD

This feature is not available for o6-MLD.

5.9.2. o6-DPL

The Direct On/Off control feature enables turning the laser On/Off using a 5 VDC signal. After having configured the laser for Direct Input operation (factory set or by executing @cobasdr 1), the laser can only start-up when 5 VDC (max 12.5 VDC) is applied to pin 3 on the Molex connector with 0 VDC on pin 2 as reference. Shifting the signal to 0 VDC on pin 3 will turn the laser off and put the laser in stand-by mode. This input only controls the on/off state of the laser and cannot be used to modulate the power output. The remote interlock connection between pin 1 and 2 must also be made as described in section 5.8 : Remote Interlock Connector.

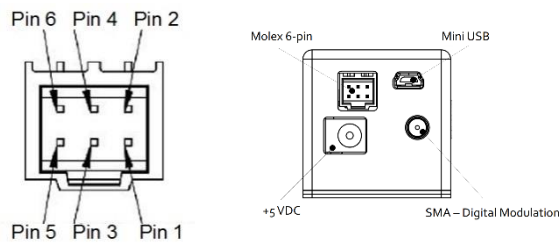

Molex connector on back side of laser head.



NOTICE This function is not available for CDRH compliant models and cannot be used with key control box.

5.10. Pin assignment

5.10.1. o6-MLD

Laser head connector – to key control box (1:1) or I/O connections for OEM lasers

The pin configuration for the 15-pin D-SUB on the MLD laser head and key control box are described in the table below.

Pin	Function
1	LED1 (Laser on)
2	LED2 (Error)
3	Analog modulation
4	0 V (ref pin 1,2,3,5,6,7,8,11,12)
5	Key Switch
6	Remote interlock connector
7	RS-232 TX
8	RS-232 RX
9	Spare
10	0 V GND (ref pin 15)
11	On/off modulation
12	<i>Not used</i>
13	<i>Not used</i>
14	<i>Not used</i>
15	+5V to key control box

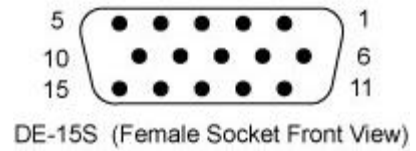

Connector pin layout on laser head and key control box

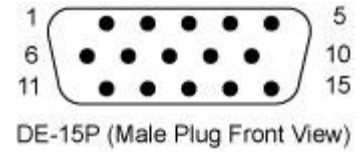

Connector pin layout for cable

Key control box connector – for RS-232 Communication with CE/CDRH compliant lasers

The pin configuration for the RS-232 socket on the key control box.

Pin	Function
1	<i>Not used</i>
2	RS232TX
3	RS232RX
4	<i>Not used</i>
5	GND
6	<i>Not used</i>
7	<i>Not used</i>
8	<i>Not used</i>
9	<i>Not used</i>

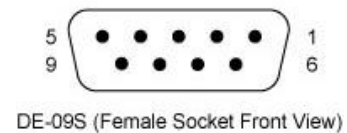

USB connector on laser head

Connector USB-type, manufacturer Hsuan Mao C8320-05BFDSBo, mates with connector mini-B.

Pin	Function
1	+5 V
2	D-
3	D+
4	Not connected
5	0 V (GND)

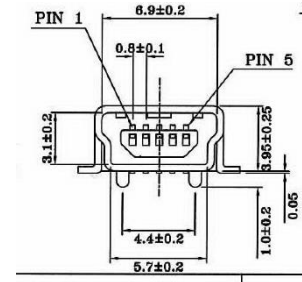

5.10.1. o6-DPL

Key box to laser head connector

The pin configuration of the Molex connector on the laser head and the 15-pin D-SUB connector on the key control box are described in the table below. Note the pin orientation with respect to the lock position of the socket of the Molex connector.

Pin	Function
1	LED ₁ (Laser on)
2	LED ₂ (Error)
3	Direct On/Off (+5 V Input) - and- Analog Modulation Signal
4	0 V Ground (ref pin 1, 2, 3, 5, 6)
5	Key Switch
6	Not used
7	Not used
8	Not used
9	Not used
10	Not used
11	Remote interlock
12	Not used
13	Not used
14	Not used
15	Not used

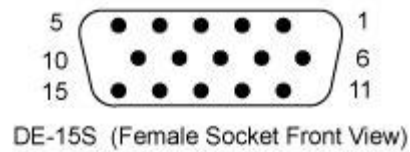
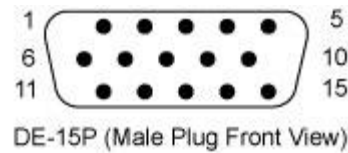

Laser head to Key box Connector

Manufacturer Molex 90130-3206, mates with Molex connector model number 90143-0006

Pin	Signal
1	Remote interlock
2	0 V – Ground Analog modulation Ground

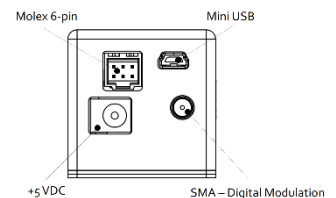
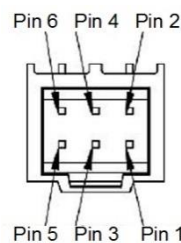

3	Direct On/Off (+5 V Input) - and- Analog Modulation Signal
4	Key Switch
5	LED 1 (Laser On)
6	LED 2 (Error)

USB connector on laser head

Connector USB-type, manufacturer Hsuan Mao C8320-05BFDSBo, mates with connector mini-B.

Pin	Function
1	+5 V
2	D-
3	D+
4	Not connected
5	0 V (GND)

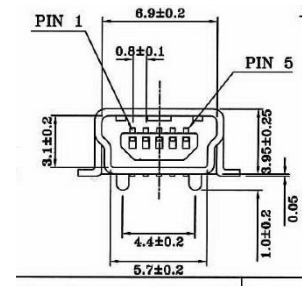

6. Controlling emission in Continuous Wave operation

In this section the different ways to control the emission of each laser in continuous wave (CW) operation will be discussed in detail. It is not recommended to use the continuous wave emission or power level controls to turn the laser ON and OFF with high speed. See section 7 : Modulation mode operation for instructions on high speed emission control.

6.1. RESTART and ABORT Button

The 'Restart' button will start the complete autostart sequence including temperature stabilization and warm up. The 'Abort' button cancels the autostart sequence and places the entire device in an OFF state. The key switch is required to restart the device when in CDRH mode. The restart button corresponds to the command 'restart', the abort button corresponds to the system command 'abort'.

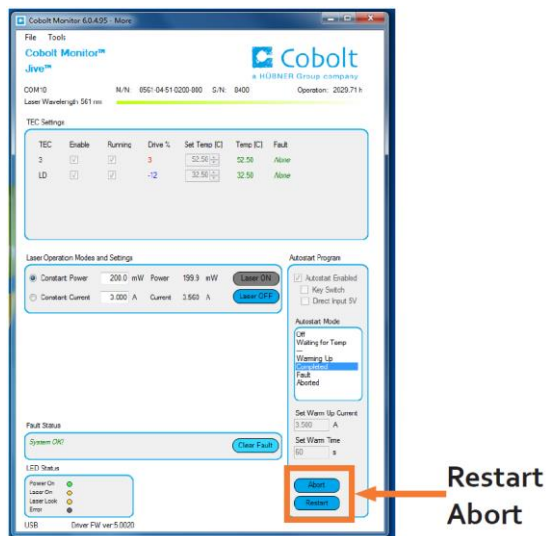

6.2. Laser ON and Laser OFF Button

The Laser ON and Laser OFF buttons can be used to stop and start emission regardless of the operation mode (constant power, constant current or modulation mode). Access to the Laser ON and Laser OFF buttons is available in the summary level of the user interface as well as the 'More' window.



NOTICE Turning the lasers ON and OFF with these buttons will require toggling of the key switch.

The ON and OFF button corresponds to the command '@cob1' for Laser ON and 'l0' for Laser OFF.

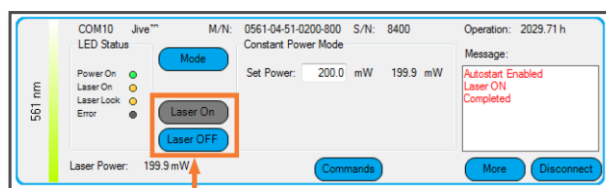

Laser ON and Laser OFF

6.3. Optical output power level controls

Cobolt lasers have two continuous-wave operating modes: **constant power** and **constant current**. In constant current mode the laser runs at a set current level. The constant power setting is used to regulate the output power level. All lasers are delivered in the most appropriate operating mode for optimized stability.

Toggle between Constant Power and Constant Current mode

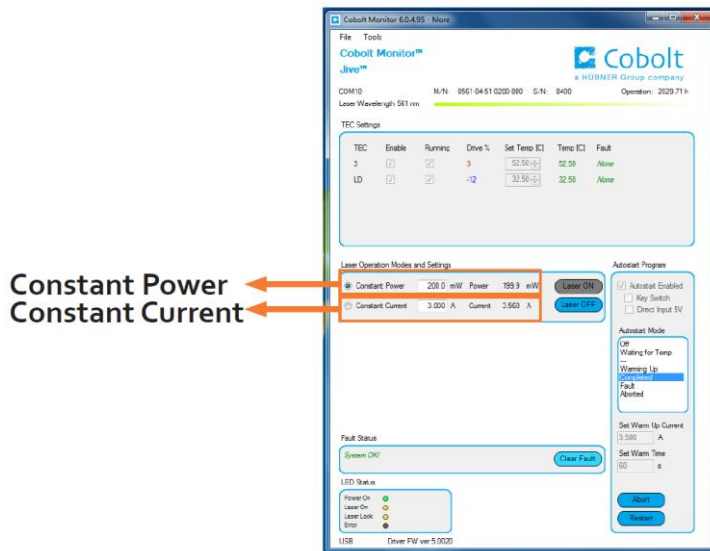
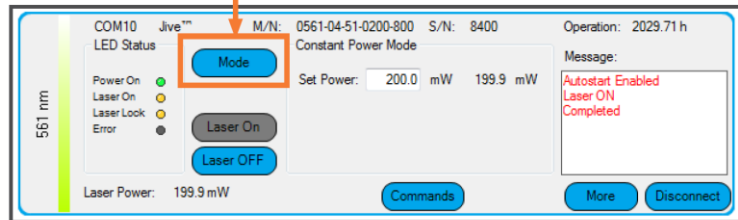

Location of emission controls in Cobolt Monitor™ Software



NOTICE Though the output power setting and drive current can be changed the other laser performance parameters are only guaranteed at 100% of nominal output power.

Constant power controls

In constant power mode the laser has a field where the output power can be set

Cobolt o6-DPL laser power controls are connected to a calibrated internal photodiode that delivers a real time power measurement and controls the drive current via a feedback loop.

Cobolt o6-MLD lasers display the power corresponding to a particular diode current from a calibrated look up table. The lasers are shipped in constant current mode to achieve optimum performance, it is not recommended to run these products in constant power mode.

To read the power setting without the Cobolt Monitor software, use the command 'p?'. The output power of the laser can be set with the command 'p X.X' where X.X is the power in **Watts (W)**. For example, to set an o6-DPL power to 25 mW the command is 'p 0.025'. The maximum allowed power is set at the factory.

Constant current controls

The laser output power can also be controlled with the current setting in constant current mode. Cobolt o6-MLD's are shipped in constant current mode to achieve optimum performance, it is not recommended to run these products in constant power mode.

To read the current setting without the Cobolt Monitor software, use the command 'i?'. The drive current, and therefore output power, of the laser can be controlled by setting the current with the command 'slc XXXX' where XXXX is the current in **milliamperes (mA)**. For example, to set the current to 2500 mA the command is 'slc 2500'.

The emission from the laser can be stopped by sending the command to set the current to zero. For example, to set the current to 0 mA the command is 'slc 0'.

The current control can be used to toggle the laser between different current settings with commands, such as between the threshold current (low or no current) and the current setting that corresponds to the nominal output power. There are safety controls in place to prevent the user from exceeding the safe maximum current for any given laser.

7. Modulation mode operation

In this section the different ways to control the emission of a laser in modulation mode operation will be discussed in detail. Cobolt o6-o1 Series laser will not operate in a digital or analog modulation mode until that mode is enabled, either in the Cobolt Monitor™ software or via the commands given in section 8.4 : Communication commands. o6-MLDs additionally offer ON/OFF modulation, which will be automatically enabled when a signal is provided to the ON/OFF modulation input but can also be controlled in the Cobolt Monitor™ software. ON/OFF modulation is activated automatically when connected. Modulation mode settings will be saved and remain enabled or disabled when powering the laser on and off.

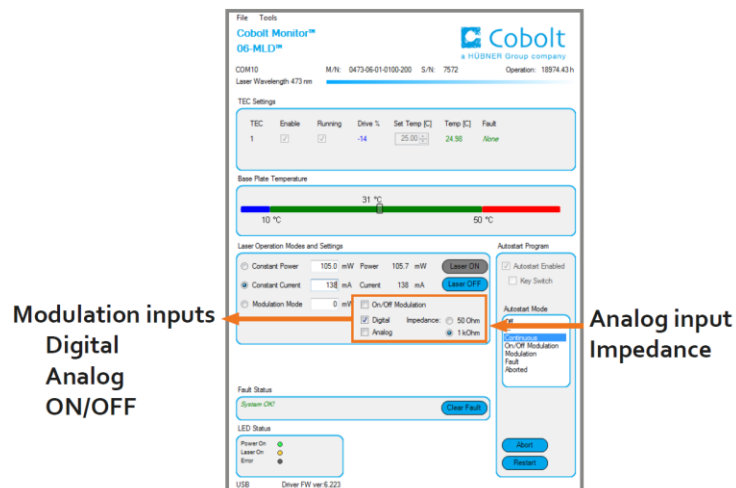
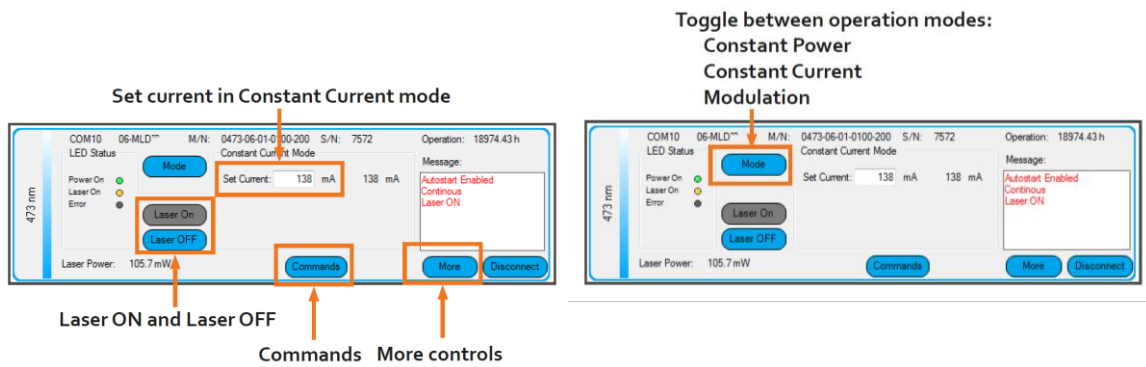

Cobolt Monitor™ software windows showing the location of modulation mode functions described in this section.

7.1. o6-MLD

Which modulation type to use?

The Cobolt o6-MLD has three different modulation types: on/off, digital and analog. These three modulation types aim to cover most applications the user may have, and they each have very different specifications.

- **On/off modulation** is quick to set up and requires no computer connection. It allows for the highest extinction ratio. Use this mode if you are modulating at speeds below 500 kHz in a square wave.
- **Digital modulation** allows for extremely fast modulation speeds of up to 150 MHz with a rise time of under 2.5 ns. Use digital modulation if you are modulating at high speeds in a square wave.
- **Analog modulation** is not as fast as digital (2 MHz), but has the advantage that the user can drive the laser with arbitrary waveforms. Use this mode if you require arbitrary waveform or DC signal to control the ON power level in CW operation or in combination with digital modulation and On/off.

These types of modulation can be used simultaneously in any combination to give complicated output shapes such as pulse bursts. These combinations are dealt with separately at the end of this section

On/Off modulation

On/off modulation is the simplest modulation type and can be used out of the box with no connection to a computer. It allows the user to completely shut off the diode between pulses, giving it a theoretically infinite extinction ratio. It does however have the narrowest bandwidth and slowest switching times of the three modulation types. The on/off modulation feature can be accessed via a socket on the key control box (CDRH model) or pin 11 on the laser head's D-SUB (OEM model).

The on/off modulation socket is connected to a floating voltage line. When this line is grounded or forced to zero, the laser automatically enters on/off modulation mode in the off state. The laser will remain in on/off mode until the laser is restarted. Note that only a very small current ($< 500 \mu\text{A}$) must flow in order to ground the circuit. A 0-5 V TTL signal should be applied to modulate the laser, and the duty cycle is set by the input signal. The on/off modulation socket takes a 3.5 mm stereo audio plug. The plug should be connected as shown in the figure below.



In Cobolt Monitor™ there is a tick box “On/Off Modulation”, which indicates when on/off modulation is active. When this is the case, all other options are greyed out, although the previous mode remains checked, as the laser remembers which state it was in previously.

The laser automatically detects when an on/off modulation signal is present and enables on/off modulation, so there is no need for the user to check the “On/Off Modulation” box manually. In the box next to this tick box the user can set the peak power level that the laser will modulate up to. This is set in the factory to the laser’s nominal maximum power level. If analog or digital modulation is enabled when On/Off modulation is enabled, the laser will operate in both simultaneously. See below for more information about modulation mode combinations.



NOTICE The on/off modulation feature should never be used as remote interlock connector. A remote interlock socket is provided for this purpose on the laser head.

Digital modulation

Digital modulation is the fastest modulation type; it has the largest bandwidth and shortest rise time. Digital modulation requires a 0-5V TTL input signal applied to the digital modulation input female SMA connector on the laser head, and the duty cycle is set by the input signal. The diode current is modulated in a square wave.

To enable digital modulation using the Cobolt Monitor™ software, select "Modulation Mode", and "Digital" under Modulation Type. You can set the peak power level that the laser will modulate up to by first pressing the "More" button which opens up a new control window and then enter your preferred value in the box to the right of the "Modulation Mode" check box.

Analog modulation

Analog modulation allows direct control of the laser power by an input signal. This allows the laser to be modulated with arbitrary waveform at limited bandwidth. To enable analog modulation, use the Cobolt Monitor software, select "Modulation Mode", and "Analog" under Modulation Type. The input signal should be connected to the Analog BNC connector on the key control box (CDRH model) or the dedicated pins on the 15-pin D-SUB (OEM model).

The laser is calibrated so that a 1 V input gives 100 % of the laser's nominal power level (for frequencies above 1 MHz it may be necessary to increase the amplitude of the analog signal up to 1.5 V). Note that the laser may give more power if a voltage larger than 1 V is used. Although the current is clamped to a safe current limit to prevent damage, the user must nevertheless avoid overdriving the diode so that it gives more than the nominal power level. Specifications and diode lifetime are not guaranteed above nominal power, which is stated on the manufacturer's identification label on the laser head. Measure the input voltage before connecting to the laser head.

When the laser is modulated from 0 V to 1 V, the current through the laser diode is modulated from slightly above zero to the current that gives the laser's nominal power. The laser diode has a threshold current below which no laser light is emitted, and above which the optical power is approximately linear with current. The figure below contains a typical power vs. current graph for a Cobolt o6-MLD 405nm laser, showing this behavior. When modulating with an arbitrary waveform, it is possible use a DC offset on the signal generator such that the laser is modulated from this threshold point to the desired maximum signal level. The threshold level varies from laser-to-laser. To determine the threshold level for a given laser apply a variable DC voltage to the analog modulation input and determining the lowest voltage where laser light is emitted. The amplitude and DC offset of the input signal should then be set so that it modulates from this point up to 1 V. Note that although the diode does not emit laser radiation below threshold, it still emits some light; modulating from 0 V will therefore give the best possible extinction ratio.

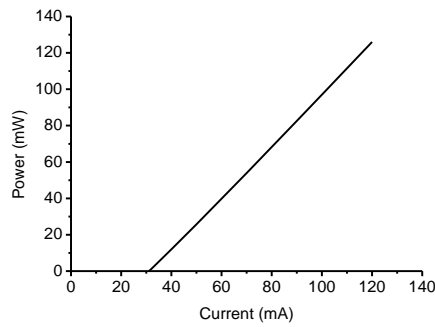

Power vs. Current for a typical 405 nm MLD laser

The user is given the choice of two impedance values for the laser's analog modulation circuit: 1 k Ω and 50 Ω . The impedance value can be toggled either in the Cobolt Monitor™ software or by software commands. The default impedance is set to 1 k Ω , and for most cases it is recommended to use this value. When using a 50 Ω signal generator, the rising and falling edges of the output may suffer ringing due to the impedance mismatch, a problem which can be solved by setting the impedance to 50 Ω . Using the low impedance will cause more of the power to be dissipated in the signal generator, so in order to modulate up to full power the user should monitor the voltage across the laser device to ensure that it reaches 1 V.

Modulation mode combinations

In addition to the modulation types described above, the Cobolt o6-MLD can be operated with a combination of modulation signals.

On/off + another mode

Any mode can be operated in combination with on/off modulation. When the laser is in modulation mode and a signal is input to the on/off modulation socket, the laser operates in both modes simultaneously. When the on/off input state is high, the laser behaves as if it were in digital or analog mode, and when it is low the laser switches off regardless of the digital or analog state. This is a useful way to produce a train of pulses.

Digital + Analog

The MLD can be used with hybrid digital + analog modulation signals. This can be accessed in the Cobolt Monitor software under the Modulation Type option. In this mode, whenever the digital state is on, the laser runs at a power determined by the analog voltage.

7.2. o6-DPL

Which modulation type to use?

The Cobolt o6-DPL has two different modulation types: digital and analog. These two modes aim to cover most applications the user may have.

- **Digital modulation** allows for modulation speeds of up to 50 kHz (532 nm), 5 kHz (553 nm), or 10 kHz (561 nm) with a rise time of under 6, 60 and 30 μ s respectively. Use digital modulation if you are modulating in a square wave.
- **Analog modulation** allows the user to drive the laser with arbitrary waveforms. Use this mode if you require arbitrary waveform.

These types of modulation can be used simultaneously in any combination to give complicated output shapes such as pulse bursts. These combinations are dealt with separately at the end of this section. Switching between types can be done using the Cobolt Monitor™ software or with direct commands.

Digital modulation

Digital modulation requires a 0-5 V TTL input signal applied to the digital modulation input female SMA connector on the laser head, and the duty cycle is set by the input signal. The diode current is modulated in a square wave. To enable digital modulation, use the Cobolt Monitor™ software, select “Modulation Mode”, and “Digital” under Modulation Type. You can set the peak power level that the laser will modulate up to by first pressing the “More” button which opens up a new control window and then enter your preferred value in the box to the right of the “Modulation Mode” check box.

The power levels are controlled by the high and low current settings. The high current is set during manufacturing to achieve up to 100 % of the nominal power in the ON state, at 1 kHz, 50% duty cycle. It is not always possible to reach 100% of nominal power in the ON state, in this case the High current level is set to the maximum of 3000 mA. The low current is determined at the factory by visually inspecting the output beam and identifying the minimum current for emission, then lowering the value by 50 mA to ensure that the current is below the threshold.

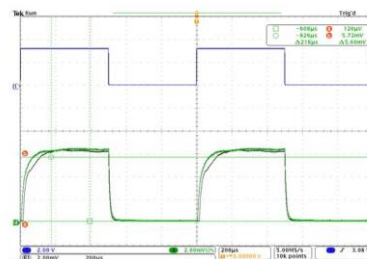

o6-DPL 561 nm digital modulation (green) with an input signal (purple) of 450 μ s on time, 50% duty cycle.

Analog modulation

Analog modulation allows direct control of the laser power by an input signal. This allows the laser to be modulated with arbitrary waveform. To enable analog modulation, use the Cobolt Monitor™ software, select “Modulation Mode”, and “Analog” under Modulation Type.

The input signal should be connected to the BNC connector on the key control box or via the 6-pin Molex connector on the back of the laser head. The laser is calibrated so that 1.3 V input results in the maximum allowed diode current. Note that the laser may give more power if a voltage larger than 1 V is used. Although the current is clamped to a safe current limit to prevent damage, the user must nevertheless avoid overdriving the diode so that it gives more than the nominal power level. Specifications and diode lifetime are not guaranteed above nominal power, which is stated on the manufacturer’s identification label on the laser head. Measure the input voltage before connecting to the laser head.

Analog modulation and direct ON/OFF cannot be used simultaneously.

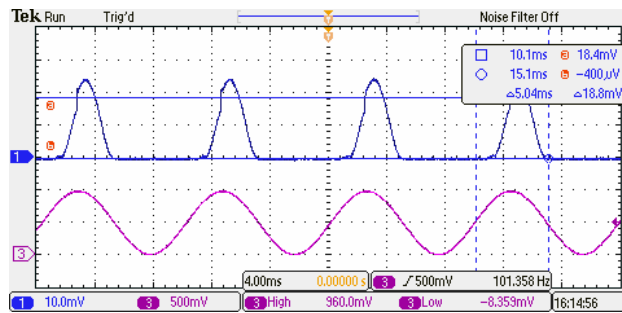

Typical analog modulation pulse shape, o6-DPL output on channel 1 (blue), function generator input on channel 3 (purple) of 0-1 V sinus, 100 Hz.

Modulation mode combinations

In addition to the modulation types described above, the Cobolt o6-DPL can be operated with a combination of modulation signals.

Digital + Analog

The o6-DPL can be used with hybrid digital + analog modulation. This can be accessed in the Cobolt Monitor™ software under the Modulation Type option. In this mode, whenever the digital state is on, the laser runs at a power determined by the analog voltage.

7.2.1. Settings Optimization in modulation mode

Cobolt Monitor™ software allows the user to optimize the laser performance while in modulation mode. During manufacturing the o6-DPLs settings are optimized for digital modulation at 1 kHz and a 50% duty cycle.

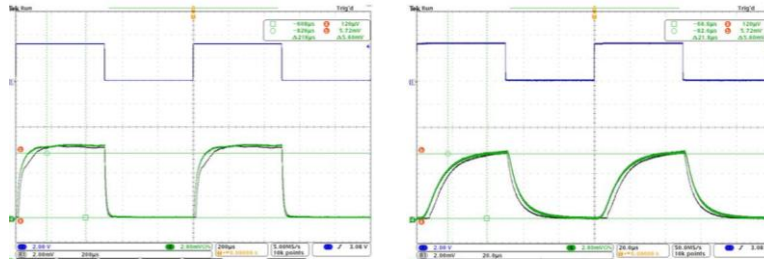

Examples of the effect of modulation frequency on pulse shape. The input signal can be seen in blue and the measured o6-DPL output signal in green. On the left a 1 kHz square wave input signal, on the right a 10 kHz input signal.

Cobolt o6-DPL modulation mode settings

When modulating with a different input signal the user can expect changes in the pulse shape, peak power and average power. Modulation mode temperature (TEC_LD_{mod}), High current and Low current can be adjusted to re-optimize performance, though 100 % of the performance may not be recoverable. The modulation settings of Cobolt o6-DPLs are optimized at the factory with a default modulation frequency of 1 kHz. The settings can be adjusted to optimize performance for the modulation scenario being used. The modulation mode temperature (TEC_LD_{mod}), high and low current settings can have strong influence on the pulse shape and can be optimized for a particular modulation frequency. The modulation mode settings can be adjusted to optimize the laser’s modulation performance in application.

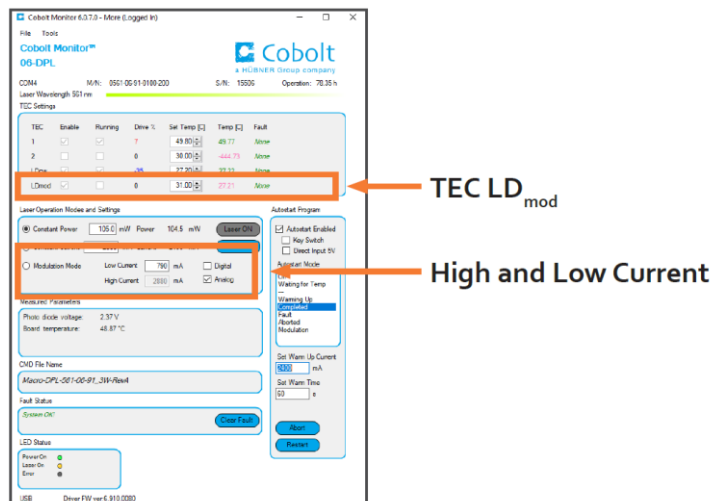

Low Current The low current defines the drive current the laser diode is set to in the **OFF** state while in modulation mode. The default factory setting is the current just below the lasing threshold. If the application requires, it is possible to set the low current to 0 mA where a perfect dark state is required. Adjusting the lower current can have adverse effects on pulse shape.

High Current The high current defines the drive current the laser diode will modulate up to while in modulation mode. The default factory setting is the current needed to reach nominal output power in the **ON** state. It is not always sufficient to increase the TEC_LD_{mod} temperature to achieve maximum average power. When necessary the High current level can be increased up to as much as 3000 mA, the maximum safe operating current for o6-DPLs as set at the factory.

TEC LD_{mod} The TEC LD_{mod} temperature can be adjusted to optimize the laser’s modulation performance in application. The o6-DPLs optical output power is influenced heavily by the match between the pump diode’s emission spectrum and the laser crystal’s gain spectrum. Modulation mode operation is achieved by direct modulation of the drive current to the pump diode. Decreasing the ON time and thereby the diode temperature, must be compensated by an increase in the platform temperature to maintain a constant pump diode wavelength. TEC_LD_{mod} is a ‘virtual TEC’ used to control the platform temperature when in modulation mode and can be used to optimize the temperature of the pump diode. Adjust the TEC_LD_{mod} temperature inversely with duty cycle.

Diode Pumped Laser Operated in CW mode

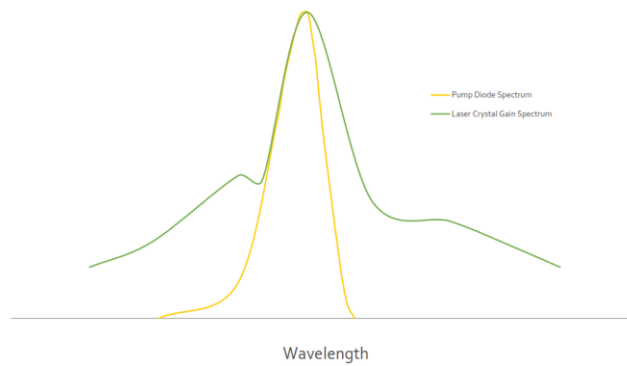

Diode Pumped Laser Operated in Modulation mode

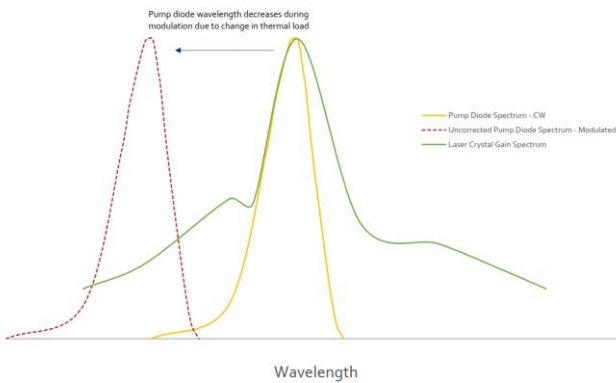

Diode Pumped Laser Operated in Modulation Mode with Thermal Compensation

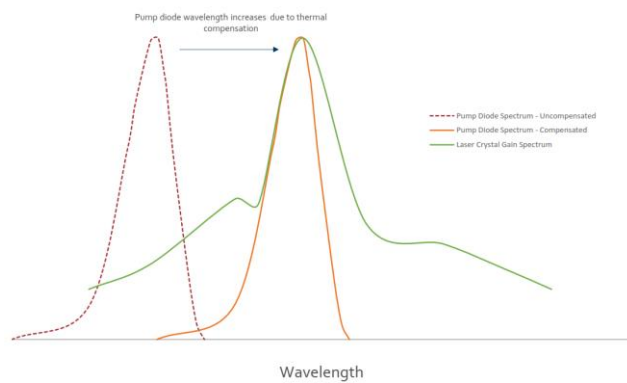

Thermal compensation for wavelength shift in modulation mode

8. Operation via data port

8.1. Data port connections

There are three ways to connect a Cobolt o6-01 Series laser to a data port. Avoid communicating via multiple interfaces simultaneously. The data connections are located as follows:

- Mini-USB connection on the laser head for USB communication. The USB cable is provided with all lasers.
- o6-MLD : 15-pin D-SUB connection on the laser head (OEM model) allows connection via RS-232 communication. See section 5.10 for the pin assignment, this cable is not standard and is not available from Cobolt.
- o6-MLD : 9-pin D-SUB connection on the key control box (CDRH model) allows communication is via RS-232.

8.2. Handshaking

Under no circumstances does the system initiate communication; it only transmits characters in response to a message. Every message generates a response, either a numerical value or the acknowledgment string "OK". If the system receives a message that it cannot interpret, it responds: "Syntax error: illegal command". Every system response is terminated by a carriage return (ASCII 13) and a full stop is used with floating numbers.

8.3. USB driver

To be able to connect to a Cobolt o6-01 series laser via USB, a USB driver must be installed on the computer. The USB driver can be downloaded from the Hübner Photonics website (<https://hubner-photonics.com/>). When installed, a virtual COM port will be created to communicate with the laser. To install the USB driver in Windows 7, follow these instructions:

1. Go to the **Control Panel** and choose **Hardware and Sound**.

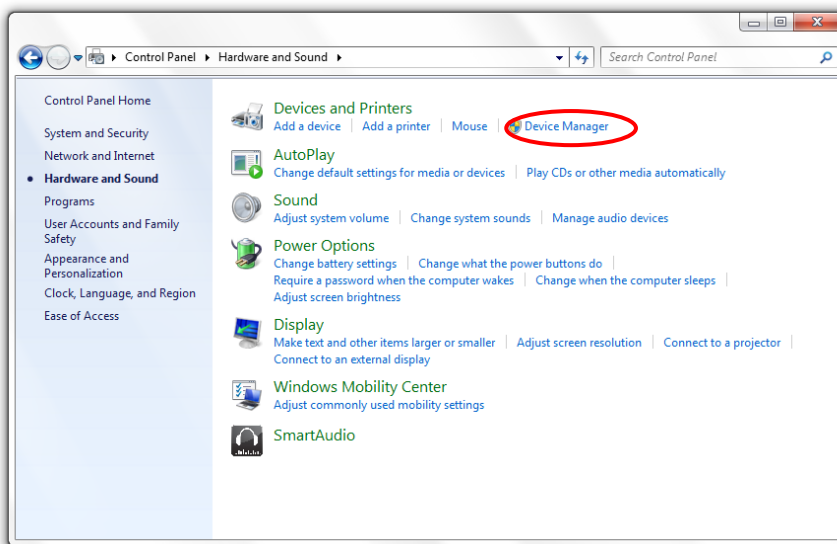

2. Under the **Devices and Printers** section, choose **Device Manager**.

- Under **Other devices**, find the device called **Cobolt Laser Driver MLD**. Right-click it and chose **Update Driver Software**.

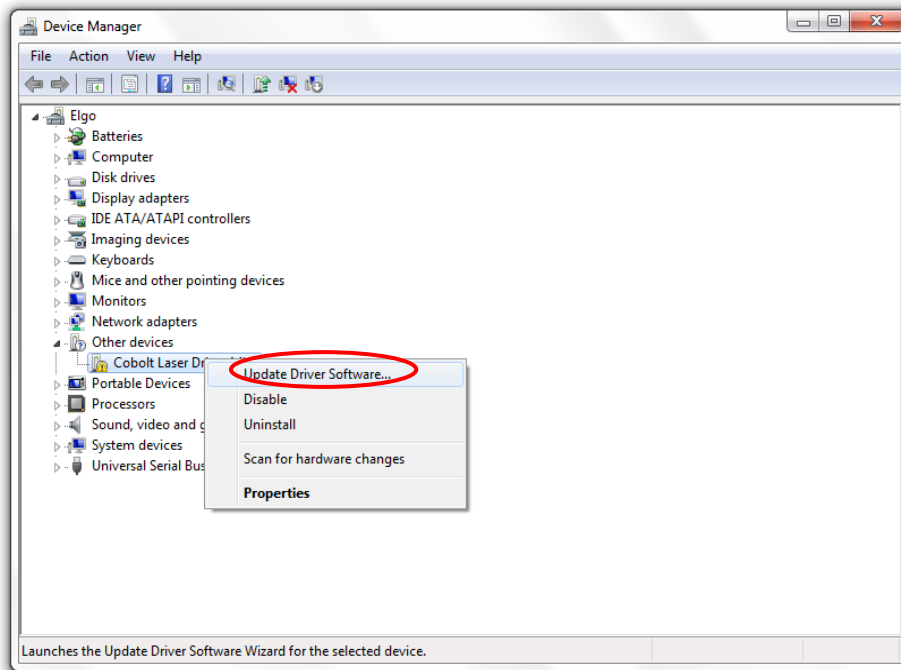

- On the next screen chose the **Browse my computer for driver software** option.

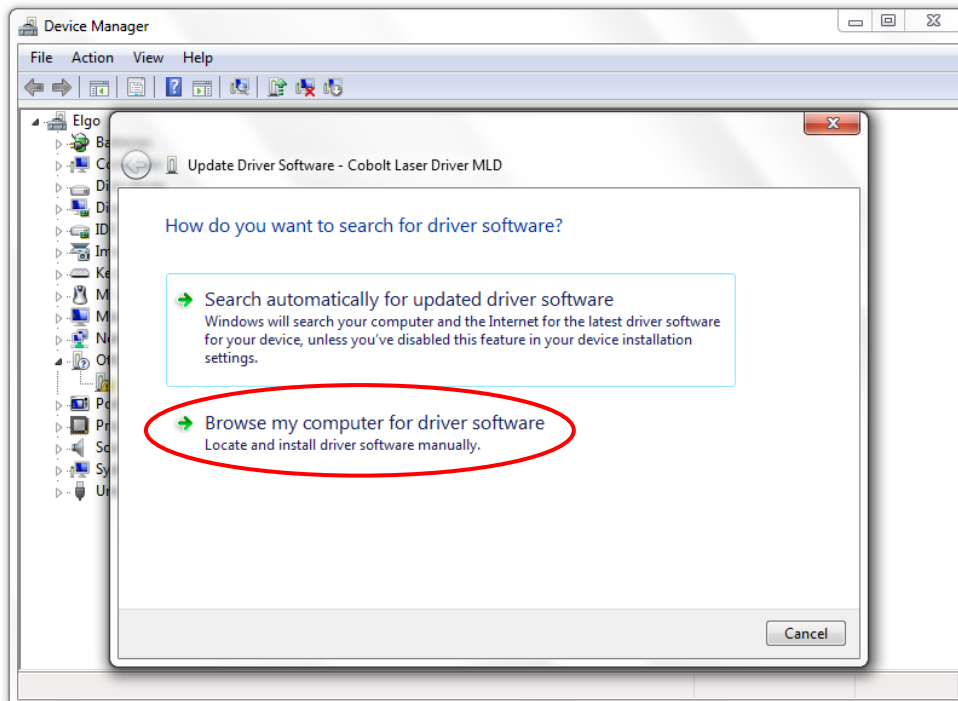

5. Click **browse** and find folder on your computer where the USB driver is stored.

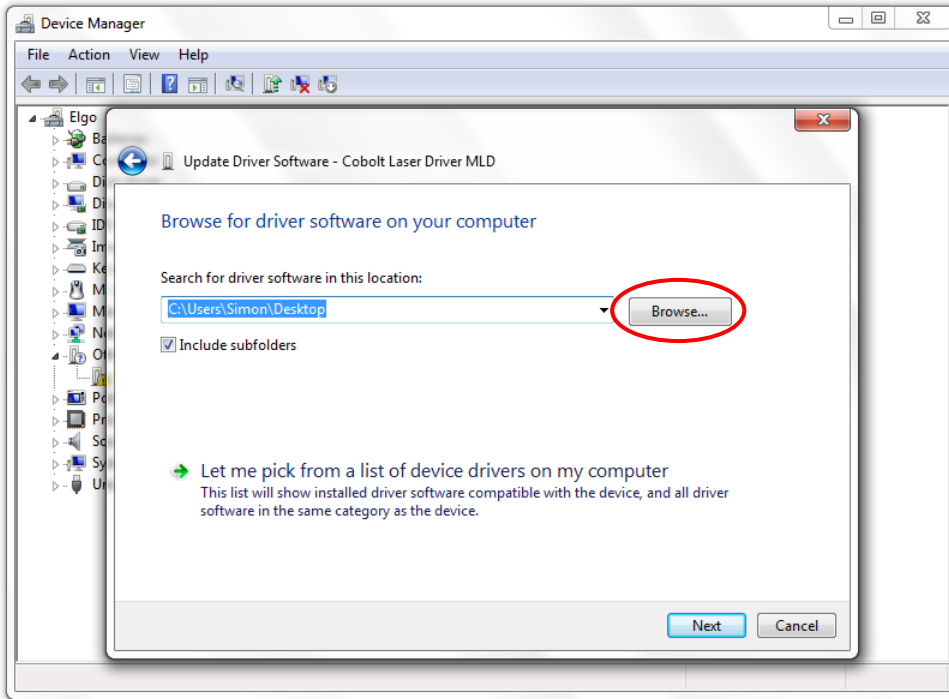

6. Windows security may warn you that the publisher of the driver is unverified. Choose **Install this driver software anyway**.

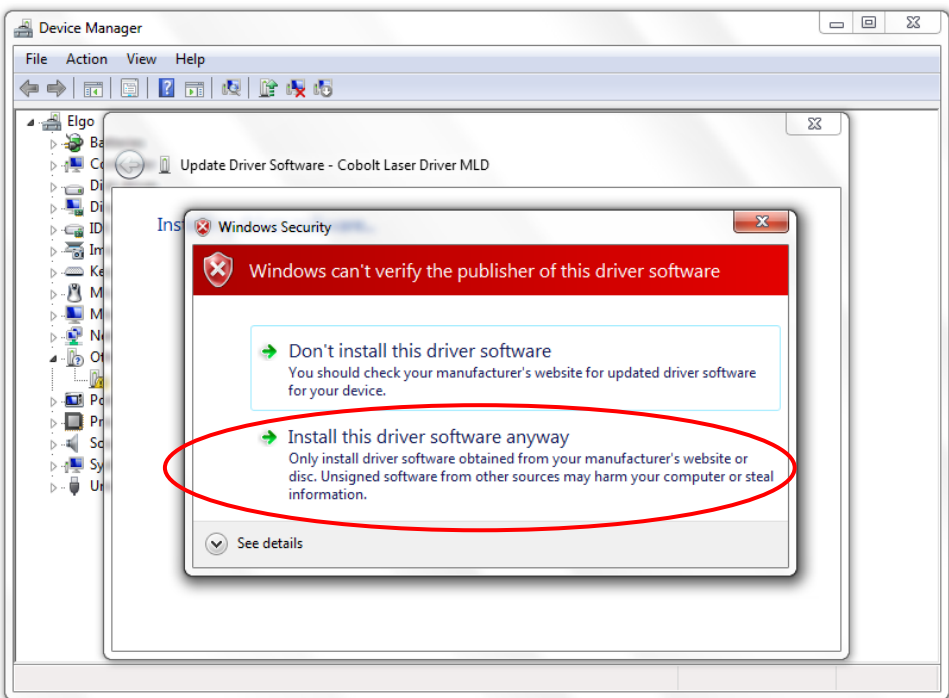

7. The installation should now be complete.

8.4. Communication commands

The laser is delivered in Auto-start mode (see section 3 for Auto-start sequence description). For system integration the Auto-start sequence can be disabled, and the following commands can be used to control the laser. If power is supplied to the laser the temperature control elements are always operating to reach set-point values and the laser will be idle waiting for the next command. All arguments are in lower case and separated by a space (ASCII 32).



NOTICE Some commands require Auto-start to be disabled but others will work when Auto-start is active.

Command	Function	Argument	Returned value
l?	Get laser ON/OFF state		0 = OFF 1 = ON
@cob1	Laser ON – Force autostart If autostart is enabled the autostart sequence will 'Restart'. If autostart is disabled, the laser will go through a forced autostart sequence.		
@cob0	Laser OFF If 'Autostart' is enabled the start-up sequence will 'Abort'. If 'Autostart' is disabled all laser will go directly into an OFF state.		
@cobasdr1	Enable 5V direct input (OEM only)		
@cobasdr0	Disable 5V direct input (OEM only)		
l1	Laser ON. Requires AutoStart to be Disabled.		
l0	Laser OFF		
@cobasks	Get key switch state		0 = Key in OFF position 1 = Key in ON position
cp	Enter constant power mode		
p?	Get output power set point		Float (W)
p	Set output power	Float (W)	
pa?	Read actual output power		Float (W)
ci	Enter constant current mode		
slc	Set laser current	Float (mA)	
glc?	Get laser current set point		Float (mA)
rlc	Read actual laser current		Float (mA)
em	Enter modulation mode		
games?	Get analog modulation enable state *		0 = disabled 1 = enabled
sames	Set analog modulation enable state *	0 = disable 1 = enable	

gdmes?	Get digital modulation enable state *		0 = disabled 1 = enabled
sdmes	Set digital modulation enable state *	0 = disable 1 = enable	
gom?	Returns the operating mode		0 – Off 1 – Waiting for key 2 – Continuous 3 – On/Off Modulation 4 – Modulation 5 – Fault 6 – Aborted
ilk?	Get interlock state		0 = OK 1 = interlock open
f?	Get operating fault		0 - no errors 1 – temperature error 3 - interlock error 4 – constant power time out
cf	Clear fault		
gsn?	Get serial number		32-bit unassigned integer
hrs?	Get laser head operating hours		Float

* Analog and digital modulation states are independent. To switch from analog to digital modulation it is necessary to disable analog and enable digital.

8.4.1. o6-MLD Specific Commands

Command	Function	Argument	Returned value
glmp?	Get laser modulation power set point	Float (mW)	
slmp	Set laser modulation power		Float (mW)
salis	Set analog low impedance (50 Ω) state	0 = disable 1 = enable	
galis?	Get analog low impedance (50 Ω) state		0 = disabled 1 = enabled

8.4.1. o6-DPL Specific Commands

Command	Function	Argument	Returned value
smc	Set modulation high current	Float (mA)	
gmc?	Get modulation high current		Float (mA)
slth	Set modulation low current	Float (mA)	
glth?	Get modulation low current		Float (mA)
stec4t	Set TEC_LD _{mod} temperature	Float (°C)	
gtec4t?	Get TEC_LD _{mod} set temperature		Float (°C)
rtec4t?	Read actual TEC_LD _{mod} temperature		Float (°C)

9. Cobolt Monitor™ Software

The Cobolt Monitor™ software provides a graphical way to monitor the laser performance and to change power, operation mode and other settings. The USB driver must be installed manually and can be downloaded from the Hübner Photonics website (<https://hubner-photonics.com/>), see section 8.3. Cobolt Monitor™ has been tested with operative systems Windows XP, Windows Vista, Windows 7 and Windows 8. Microsoft .NET 2.0 is required to run the Cobolt Monitor™ software. Most computers with operative systems Windows XP, Windows Vista, Windows 7 and Windows 8 have this included as standard.

9.1. Installation

Download the latest version of the Cobolt Monitor™ software from the Hübner Photonics website (<https://hubner-photonics.com/>). The Cobolt Monitor™ software is a stand-alone executable, the executable file is packaged with other files needed to run the program in a .zip file. Save the .zip file any storage device and extract all files. The folder created after extracting the files can be placed on any storage device and Cobolt Monitor™ can be run from there. All files and folders contained in the .zip file must be present for the program to function properly.

9.2. Software instructions

The software automatically searches for Cobolt devices every 5 seconds and automatically connects the laser if detected. The software can identify USB connected lasers as well as RS232 connected lasers (o6-MLD only).

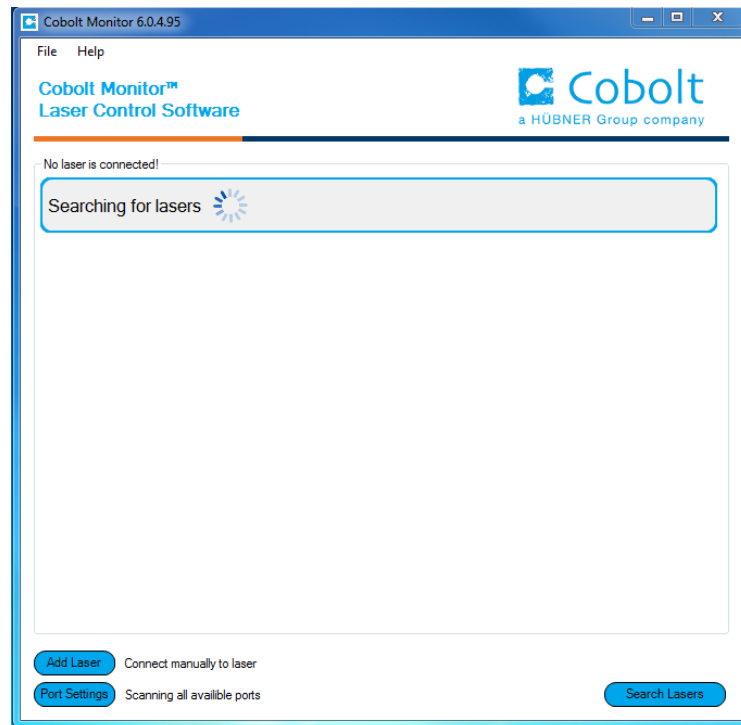

The first Cobolt Monitor™ window that appears in the software.

Once the laser is connected it can be controlled from the box dedicated for the laser. Only the relevant information is presented on this level, displaying only the status the laser is in and relevant choices to make. Here follows a short description of how to use the Cobolt Monitor™ software on this level.

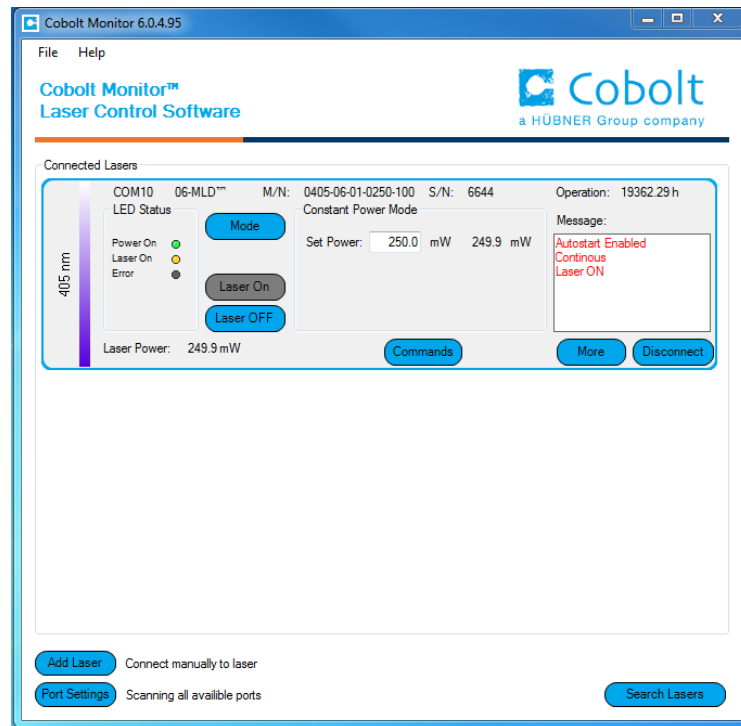

Laser successfully connected.

Laser ON – Turns the laser ON. If the laser is in autostart mode, this is equivalent to “restart”.

Laser OFF – Turns the laser OFF.

Mode – Gives a choice of operational modes possible to choose for the laser model. For o6 series laser models Constant Power, Constant Current or Modulation mode operation can be chosen. Only relevant choices for the mode of operation are presented.

Commands – opens a command communications window to send commands directly to the laser.

Message – highlights important information of the laser status to the user.

Disconnect – allows the user to disconnect from the Cobolt Monitor™ software in a controlled way.



NOTICE The communication cable should not be removed when the software is in connect state. The communication within the laser may then malfunction and this might require a power restart of the driver. To disconnect the laser, click “Disconnect” or close Cobolt Monitor™ completely. It is also possible to disconnect by powering the laser OFF. In this case Cobolt Monitor™ will automatically close the window for that laser.

Clear Fault - is displayed in the event of a fault. The user can deal with the cause of the fault and then press “Clear Fault” and then restart the laser by clicking “Laser ON”. Example: if the remote interlock loop is open the user must make sure the loop is closed again before issuing a “Clear Fault” followed by “Laser On”.

More –an additional Cobolt Monitor™ window will open containing more detailed information of that laser’s status.

g.2.1. o6-MLD

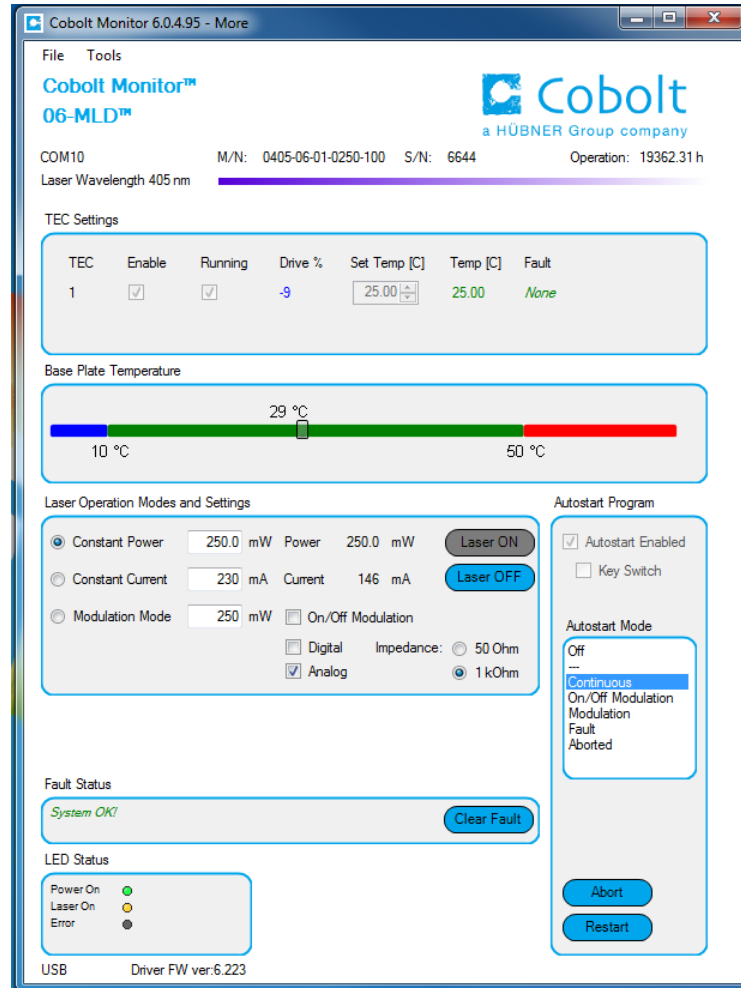

Cobolt Monitor™ software expanded to for more detailed monitoring.

TEC Settings – shows the running status and the fault status for the laser’s internal thermoelectric coolers (TEC).

Laser Operation Mode and Settings - The user can switch between constant power mode, constant current mode and modulation mode. Likewise, there are boxes to set the constant power level and constant current level. In constant power mode the current will be set by Cobolt Monitor to reach the power level set in this field. When in modulation mode it is recommended to use an external power meter. See section 6 and 7 for more details on continuous wave and modulation modes.

Autostart Program - displays whether the laser is in CDRH or OEM mode and displays the current laser operational status. There are also buttons to “abort” the autostart sequence or to “restart” the laser after a fault.



NOTICE Specifications are only guaranteed in constant current mode, at 100% of nominal power.

Fault Status – displays ERROR messages. In the event of an ERROR, the laser action is stopped. When the reason for the ERROR event is understood and the problem is addressed the fault status can be cleared with “Clear Fault”. If the Autostart Program is enabled, click restart to restart the laser.

LED Status - displays the LEDs that are currently illuminated on the key control box, see section 4.3. These are displayed even if the laser is in OEM mode.

POWER	Green	Power is supplied.
ON	Orange	Laser emission is on. This light is on in modulation mode if laser emission is possible.
ERROR	Red	An error has occurred.

9.2.2. o6-DPL

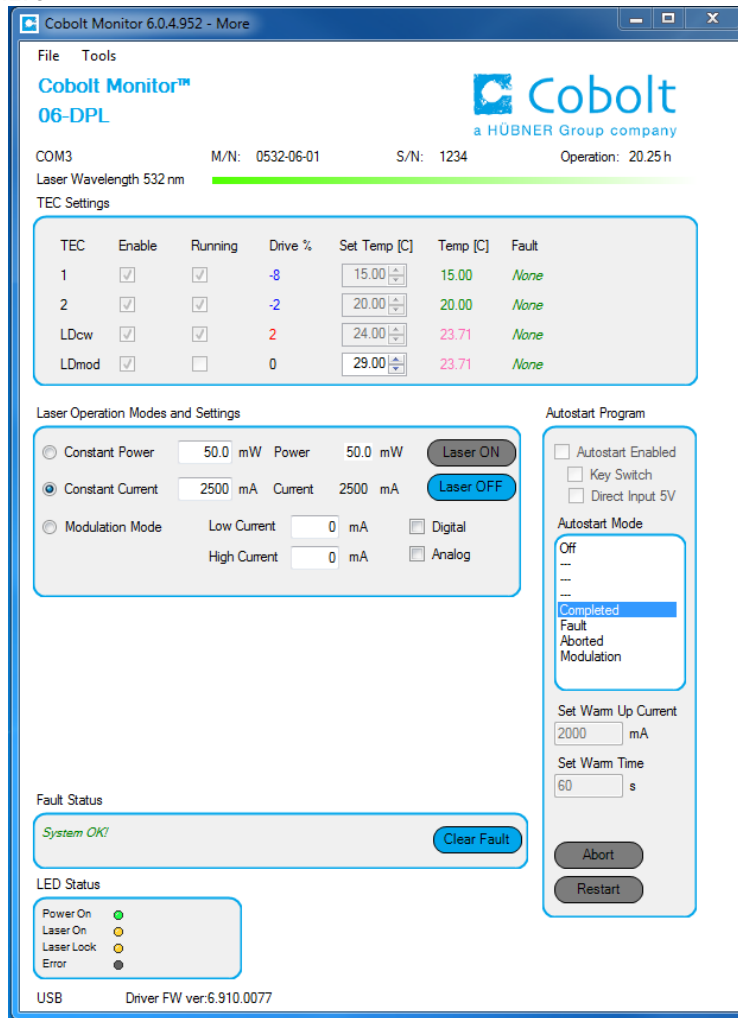

Cobolt Monitor™ software expanded to for more detailed monitoring.

TEC Settings – shows the running status and the fault status for the laser’s internal thermoelectric coolers (TEC). TEC 1, TEC 2 and TEC LD_{cw} are factory set for optimum laser performance and cannot be changed. TEC_LD_{mod} controls the platform temperature in modulation mode.

Laser Operation Mode and Settings - The user can switch between constant power mode, constant current mode and modulation mode. Likewise, there are boxes to set the constant power level and constant current level. The output power (measured on an internal photodiode) and the current through the laser pump diode are both displayed. When in modulation mode it is recommended to use an external power meter, the power displayed in the software is not actual. See section 6 and 7 for more details on continuous wave and modulation modes.

Autostart Program - displays whether the laser is in CDRH or OEM mode and displays the current laser operational status. There are also buttons to “abort” the autostart sequence or to “restart” the laser after a fault.



NOTICE Specifications are only guaranteed in constant power mode, at 100% of nominal power.

Fault Status – displays ERROR messages. In the event of an ERROR, the laser action is stopped. When the reason for the ERROR event is understood and the problem is addressed the fault status can be cleared with “Clear Fault”. If the Autostart Program is enabled, click restart to restart the laser.

LED Status - displays the LEDs that are currently illuminated on the key control box, see section 4.3. These are displayed even if the laser is in OEM mode.

ON Orange Laser emission is on. This light is on in modulation mode if laser emission is possible.

ERROR Red An error has occurred.

10. Troubleshooting

Below are some possible problems along with a list of things to check if the problem occurs.

No laser emission 3 minutes after start-up

1. Verify the remote interlock connector is connected and restart the laser.
2. Verify that autostart is enabled. Click the restart button in the Monitor software or send the command "@cob1" to force a restart of the laser.
3. Ensure the laser has adequate heat sinking.
4. Verify the supply voltage is within the range stated in section 4.5.
5. Check the base plate temperature (this is displayed in the Cobolt Monitor™ software). If it is outside of the range 20-50 °C the laser may take longer to stabilize the temperature or be unable to do so.
6. Remove all modulation input and make sure the laser is in constant power mode (in the software or with the "cp" command) then restart the laser.
7. Send the command "f?"
8. If fault code 1 is returned, check that the heat sink is adequate, and that the ambient temperature is under 40°C.
9. If fault code 3 is returned, see interlock fault checklist.
10. If fault code 4 is returned, there may be a problem with the constant power system.
11. Contact Cobolt representative.

Interlock fault

1. If using a custom interlock system, connect the Cobolt-supplied remote interlock connector plug to check whether the interlock is correctly wired.
2. This remote interlock connector should be connected as described in section 5.8.
3. In the software, check that "Interlock Fault" is not displayed. Send the command "ilk?" to confirm the Remote Remote interlock connector is not open (returns a 1 if closed).
4. If it is verified that the Remote Interlock Connector system is closed yet an interlock fault is returned, contact Cobolt technical support.
5. Laser emission stops.
6. Ensure the laser has adequate heat sinking.
7. Check the base plate temperature (this is displayed in the Cobolt Monitor™ software). If it is outside of the range 20-50 °C the laser may take longer to stabilize the temperature or be unable to do so.
8. Check that the Remote Interlock Connector is connected.
9. Send the command "f?"
10. If fault code 1 is returned, check that the heat sink is adequate, and that the ambient temperature is under 40°C.
11. If fault code 3 is returned, see interlock fault checklist.
12. If fault code 4 is returned, there may be a problem with the constant power system.
13. Contact Cobolt representative.

Low power

1. Check that the laser is in constant power mode (using the GUI or the "cp" command).
2. Check the power reading using the GUI or the "pa?" command.
3. If this does not agree with the real output power, re-calibrate by measuring the power and entering it in the "Power Cal" box in the software.
4. Remove any connector from the ON/OFF MOD socket on the key control box (or pin 6 on the laser head's D-SUB in OEM mode) then restart the laser.
5. Send the command "f?" If fault code 4 is returned, there may be a problem with the constant power system.
6. Contact Cobolt representative.

11. Warranty and Maintenance

The Cobolt lasers should not be opened for any reason. The warranty will be void if any of the system units are opened. All laser parameters are set at the factory, and there are no adjustments required (other than those described in this manual for operating in different modulation modes and at different power levels).

Cobolt provides a system warranty of 24 months after delivery with unlimited hours of operation on wavelength 375 nm – 561 nm and a 24 month or 5000 hour limited warranty on wavelengths > 600 nm. The laser systems are designed for modular replacement or repair if the laser head or key control box malfunctions. The fiber pigtailed option has a 12-month limited warranty on fiber related workmanship. The warranty is invalid if the laser system is operated outside of the specific limits and conditions as outlined in this document.

12. Service

Due to accuracy tolerances, calibration differences and allowed power drift there may be discrepancies between the Cobolt measurement of the optical output power and the customer measurement equipment. If the output power deviates from the reported value please contact your local Cobolt representative for an online re-calibration.

If the laser does not function, do not attempt to open any of the units, or the warranty will be voided. Call or e-mail your local Cobolt representative for consultancy and to request an RMA number (see back cover for contact information). If an RMA number is issued and the laser needs to be shipped back to Cobolt or your local representative, please pack the complete system for shipment using the original package or equivalent. Ensure the unit is free from thermal paste before packing. The warranty covers repair or replacing the unit at the option of Cobolt.

13. Compliance (CDRH models only)

The CDRH model lasers (-1/300) are designed and manufactured to comply with the EC Low Voltage Directive and the EC EMC Directive in the CDRH-compliant configuration of laser head, key control box, key and Cobolt-supplied power supply. All equipment must be mounted on a common ground plane, such as an optical table. If any part of the delivered equipment is replaced with a part not supplied by Cobolt or if the equipment is not properly grounded, the system may not conform to CE / CDRH compliance standards listed here. Disabling any of the safety features nullifies the CE marking and violates the laser safety standard.



The following harmonized and limits standards have been applied:

Electrical Safety	EN 61010-1, IEC-61010-1, UL 61010-1 (Limited Energy System) UK S.I. 2016 No. 1101 : The Electrical Equipment (Safety) Regulations 2016
Laser Safety/Class	IEC-60825-1 FDA / CDRH : Complies with 21 CFR 1040.10 and 1040.11 except for conformance with IEC 60825-1 Ed. 3., as described in Laser Notice No. 56, dated May 8, 2019.
EMC	IEC 61326-1 EN 55011 Electromagnetic Emission , Class A Electromagnetic Immunity – Table 2 Requirements EN 61000-4-2 Electrostatic Discharge ±4 kV contact discharge and ±2 kV, ±4 kV, ±8 kV air discharge EN 61000-4-3 Radiated electromagnetic fields 80 – 1000 MHz, 10 V/m with 80 % AM @ 1 kHz 1.4 – 2.7 GHz, 3 V/m with 80 % AM @ 1 kHz EN 61000-4-4 Fast transient / Burst AC Power input port ±2,0 kV EN 61000-4-5 Surge AC Power input port ±0,5 kV, ±1,0 kV, ±2,0 kV Com. Mode AC Power input port, ±0,5 kV, ±1,0 kV Diff. Mode EN 61000-4-6 Conducted Immunity 3 V with 80 % AM @ 1 kHz EN 61000-4-11 Dips and Interruptions 50 Hz and 60 Hz. Test voltages: 100 V and 230 V UK S.I. 2016 No. 1091 : Electromagnetic Compatibility Regulations 2016 FCC 47 CFR - Part 15 (2009): Subpart B, Class A
RoHS	EU Directive 2011/65/EU, EU 2015/863 and amendment EU 2017/2102 UK S.I. 2012 No. 3032

Contact your sales representative for a copy of the full Declaration of Conformity.

14. Disclaimer

Cobolt will assume no responsibility for damage incurred by faulty customer equipment, such as measurement equipment, cables etc., used in conjunction with Cobolt lasers. Cobolt makes no warranty of any kind with regard to the information contained in this guide, included but not limited to, implied warranties of merchantability and suitability for a particular purpose. Cobolt shall not be liable for errors contained herein nor for incidental or consequential damages from the furnishing of this information. No part in this manual may be copied, reproduced, recorded, transmitted, or translated without the express written permission by Cobolt.

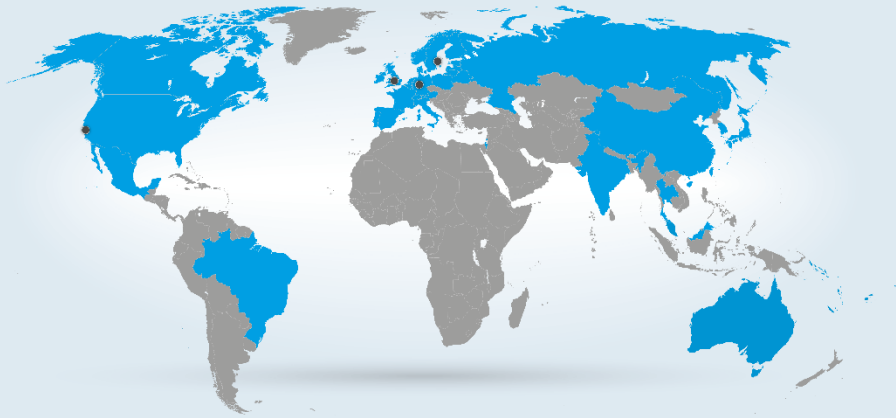

Our Locations

Cobolt AB

(Sales in Norway, Sweden, Finland and Denmark)

Solna, Sweden

Phone: +46 8 545 912 30

Fax: +46 8 545 912 31

E-mail: info.se@hubner-photonics.com

HÜBNER GmbH & Co. KG

(Sales in Germany, Switzerland and Austria)

Kassel, Germany

Phone: +49 561 994 060 - 0

Fax: +49 561 994 060 - 13

E-mail: info.de@hubner-photonics.com

HÜBNER Photonics Inc.

(Sales in USA, Canada and Mexico)

San Jose, California, USA

Phone: +1 (408) 708 4351

Fax: +1 (408) 490 2774

E-mail: info.usa@hubner-photonics.com

HÜBNER Photonics UK

(Sales in UK and Ireland)

Derby, Great Britain

Phone: +44 7359440871

E-mail: info.uk@hubner-photonics.com

hubner-photonics.com

HÜBNER Photonics

